

SLIGHT

FLOW 20 CATALOG

2025

slightly different



Slight[®]
slightly different

System overview

Straight track

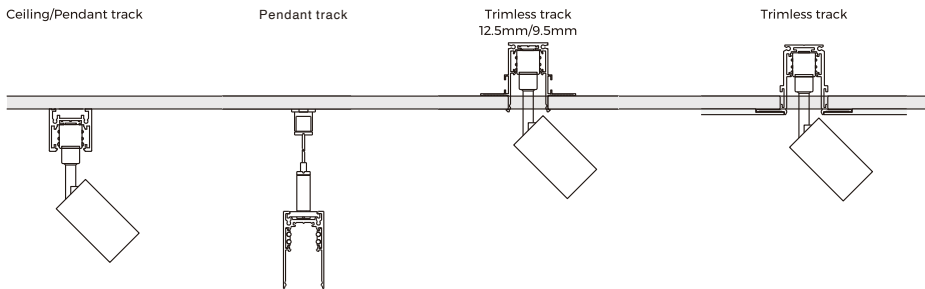

Curve track

Trimless track (12.5mm/9.5mm)

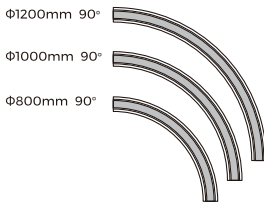

Pendant track

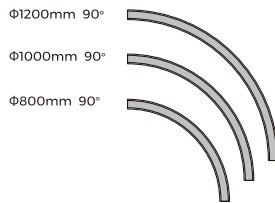

Spotlight Module

Φ30mm spotlight



Φ42mm spotlight



Φ52mm spotlight



Φ62mm spotlight



Φ45mm zoom spotlight



Φ55mm zoom spotlight



Φ65mm zoom spotlight



Decorative Module

Sunset light



Waterdrop light



Sphere light



Φ30mm tube light



Round Φ30mm spotlight



Φ50mm spotlight



Linear Module

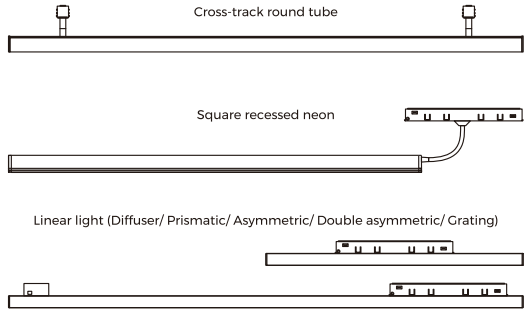
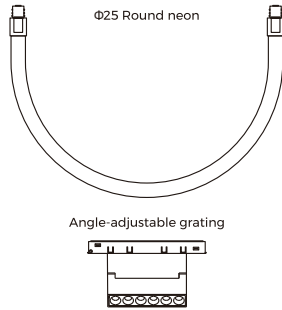

Optics

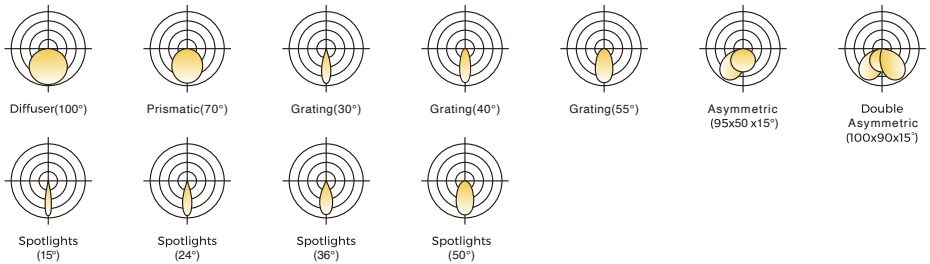

Corner

L-shaped (Downward/Inward)



L-shaped Adjustable (Downward)



T-shaped Adjustable (Downward)



X-shaped Adjustable (Downward)



CCT



Dimming



Certifications



Type of track

Straight track

It supports including pendant, ceiling and recessed installation, can be flexibly chosen to fit all kinds of practical needs.

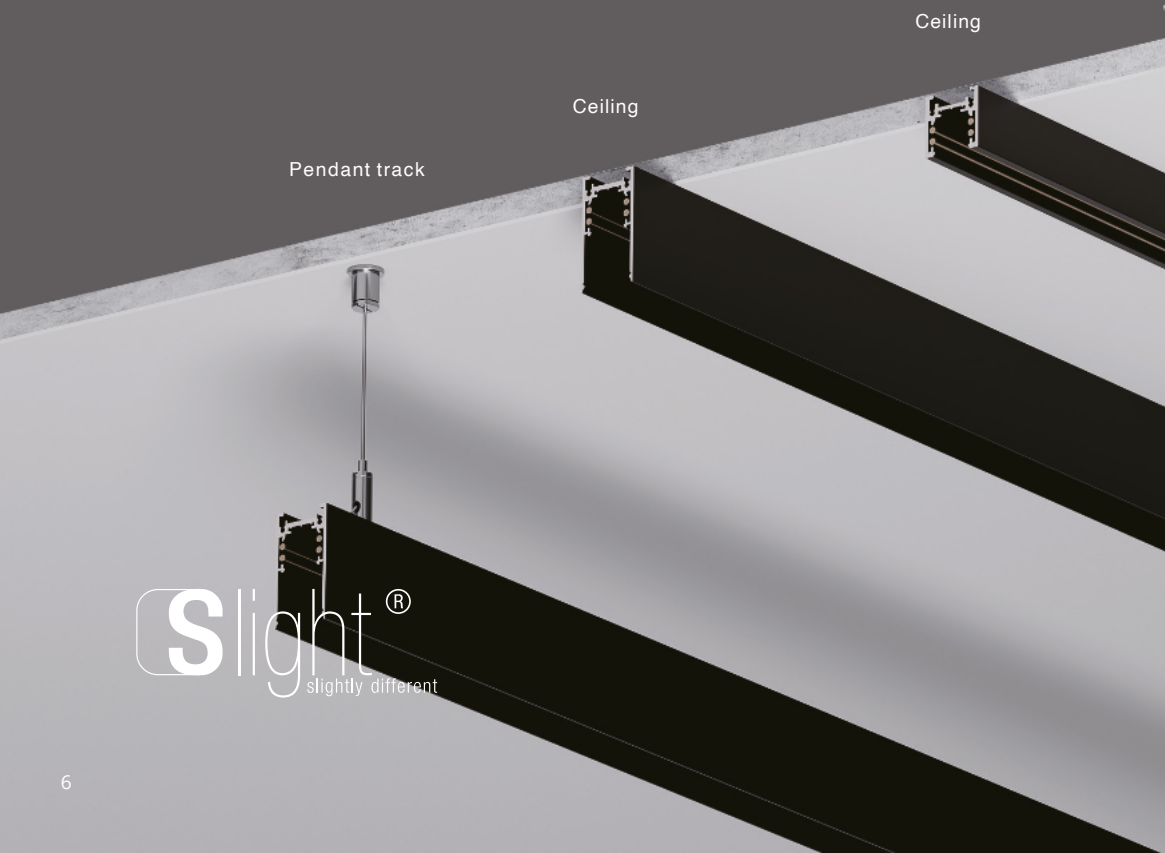

Slight®
slightly different

Trimless track
12.5mm

Trimless track
9.5mm

Trimless track

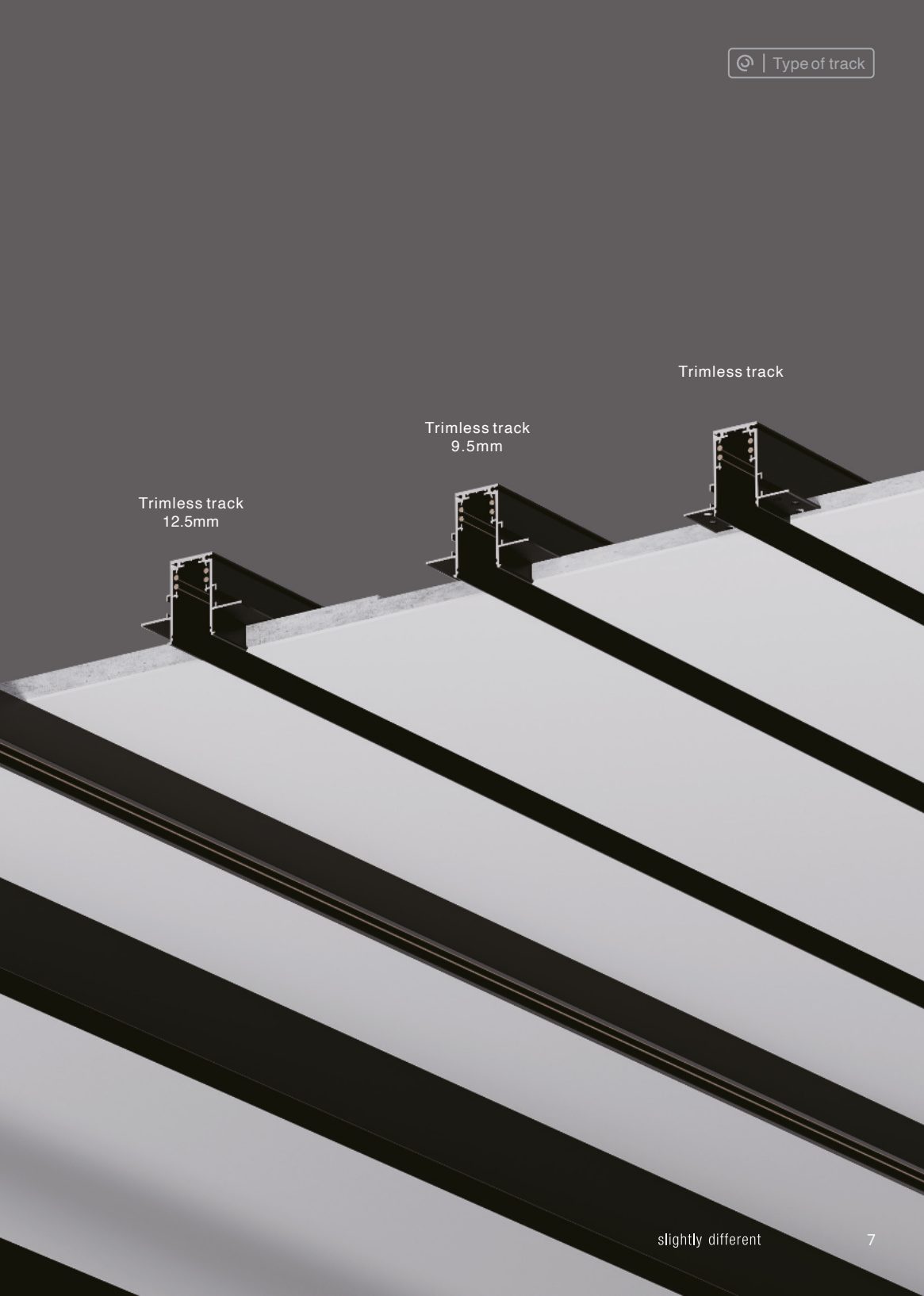

Curved track

The rotation angle is 90 degrees

90°

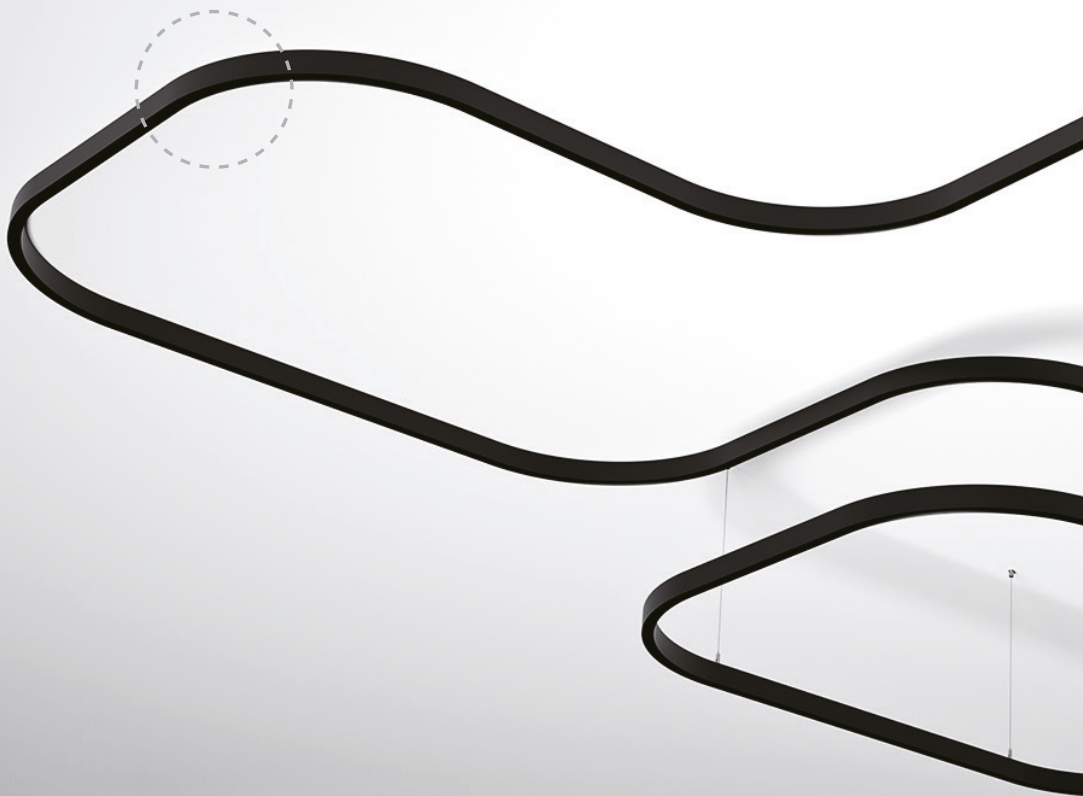

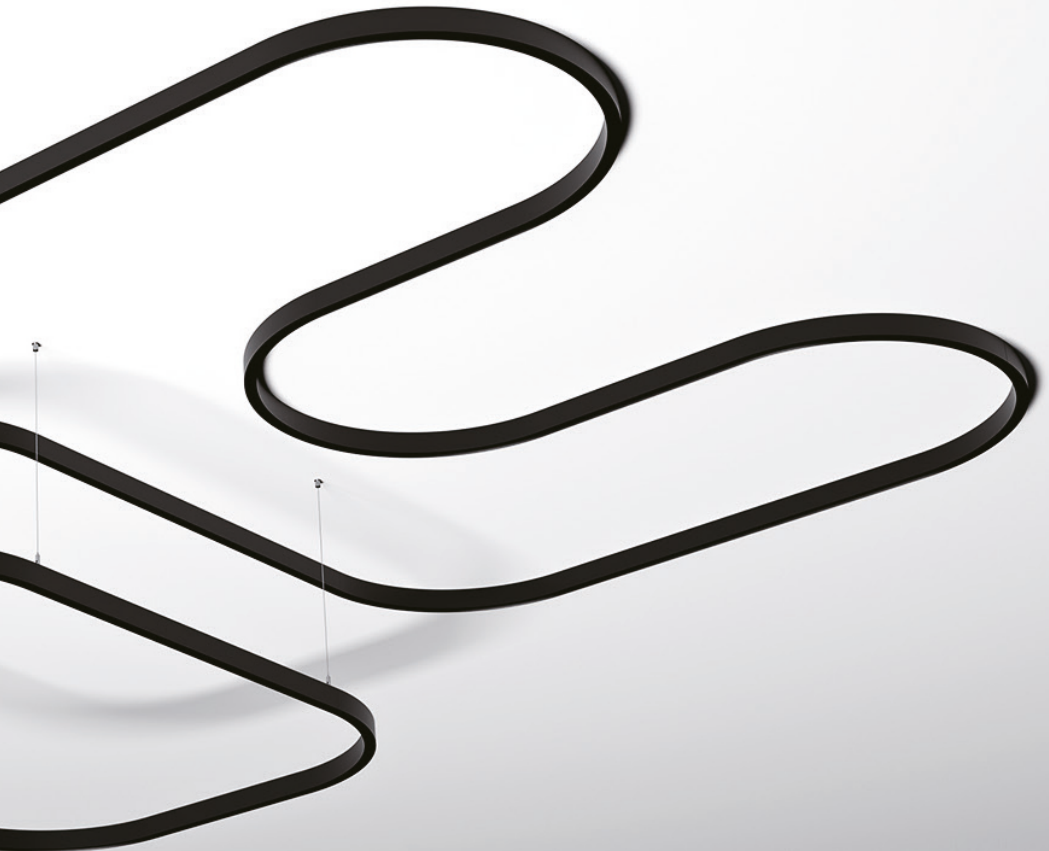

Curved track

Combine with straight track for more possibilities



Trimless track
(12.5mm/9.5mm)

Pendant track

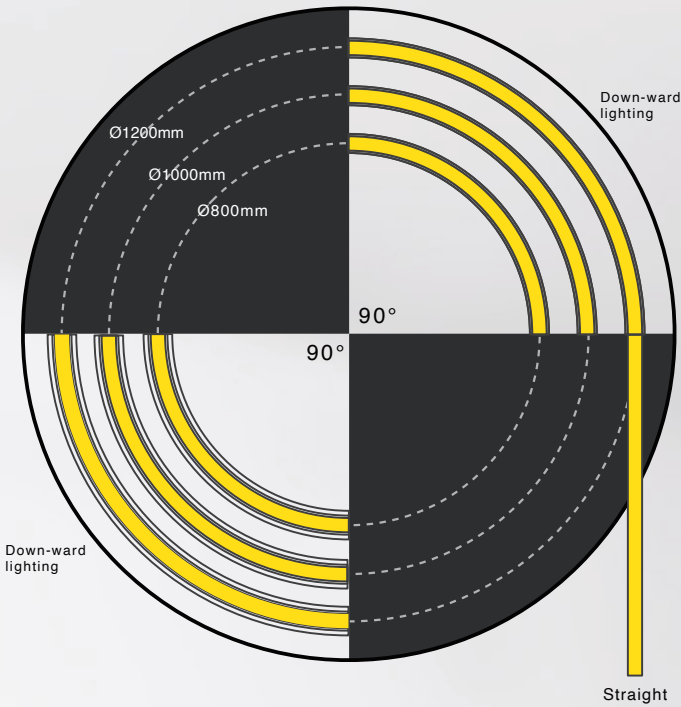



slightly different

Variety of designs

Straight lines and curves shuttle freely to realize various shapes and designs.





Track splicing

Easy splicing

Very convenient and efficient in track splicing

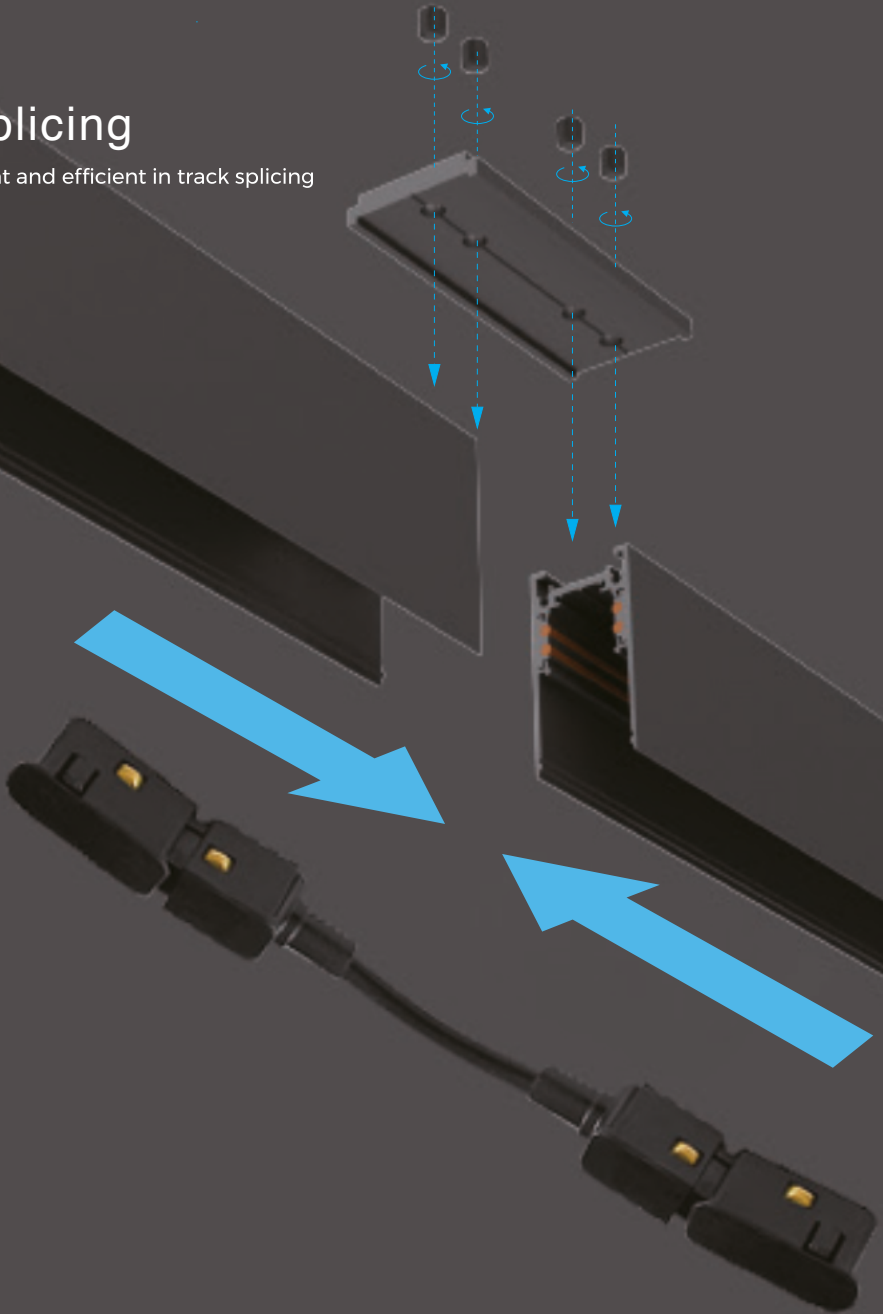

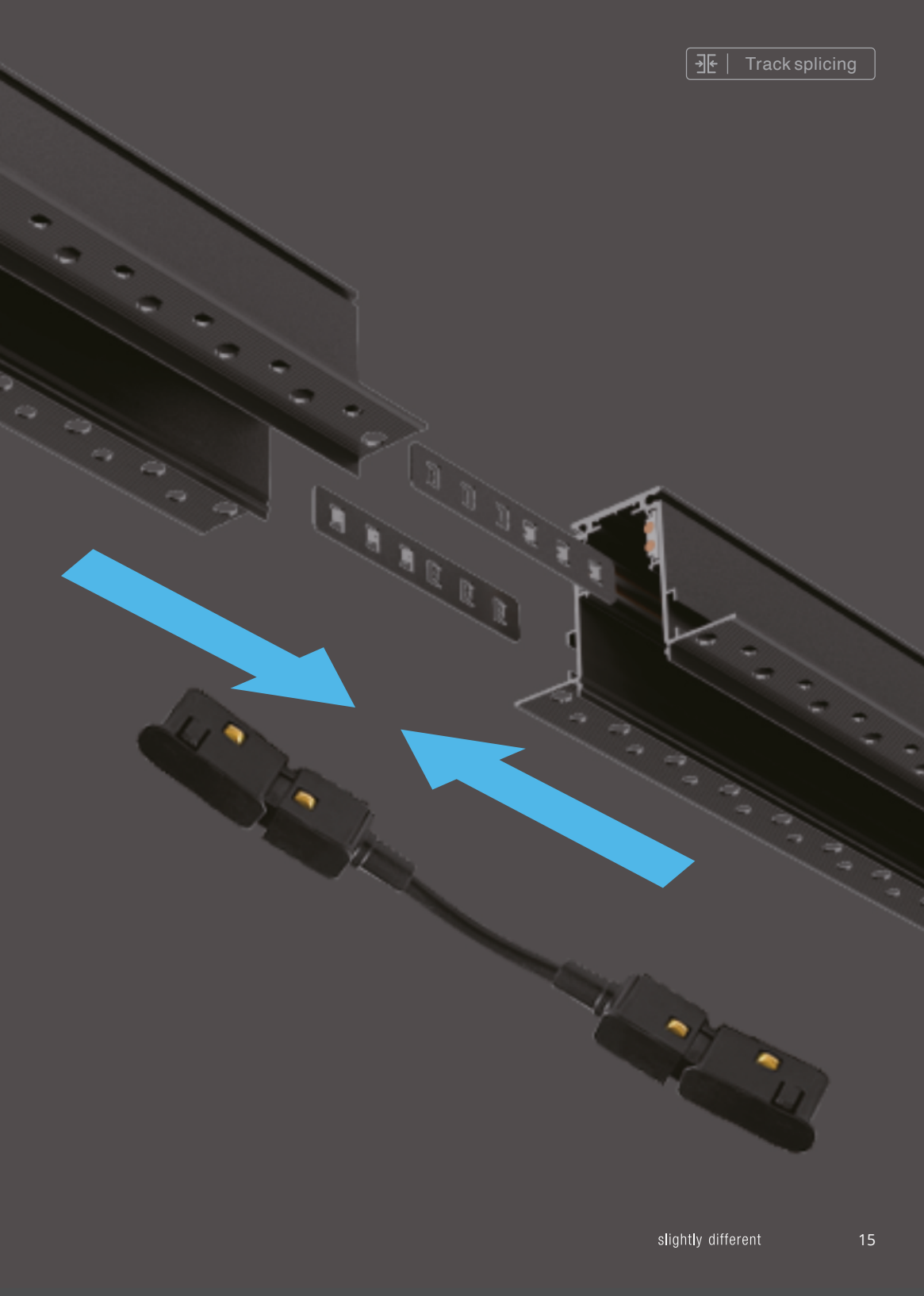

Standard connector

13 finished accessories, no need to cut, can achieve seamless splicing

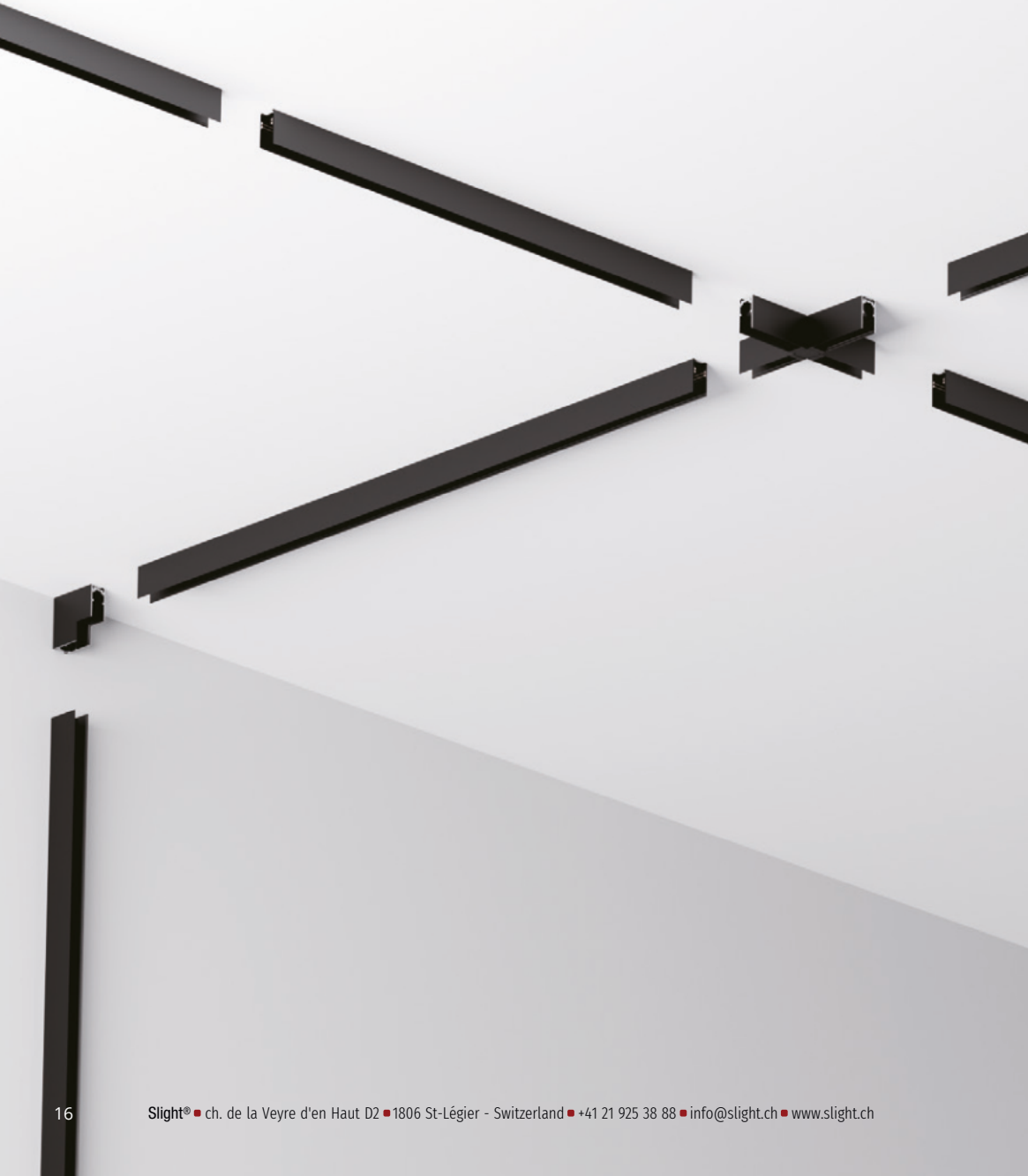

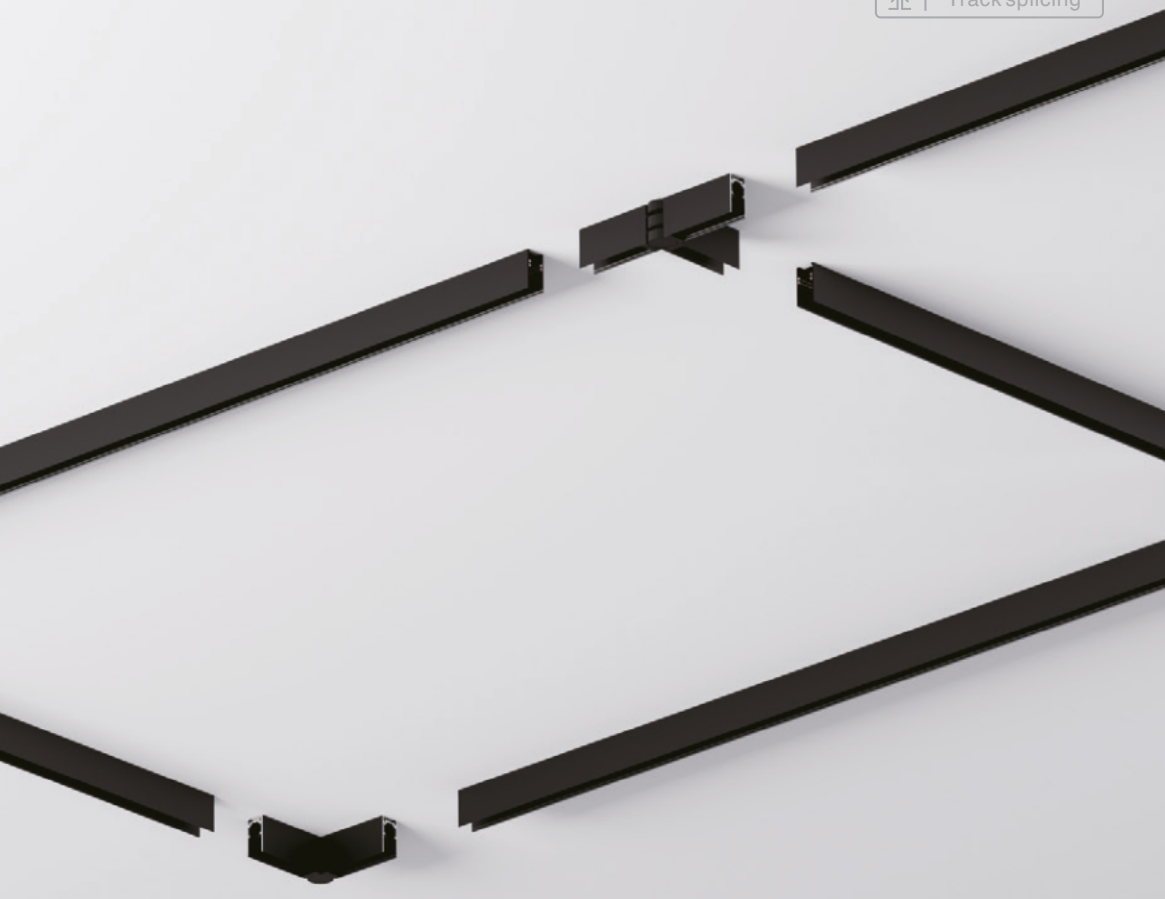

Straight corners

L-shaped, T-shaped and X-shaped corners can be realized, and the angle can be adjusted to achieve more possibilities.

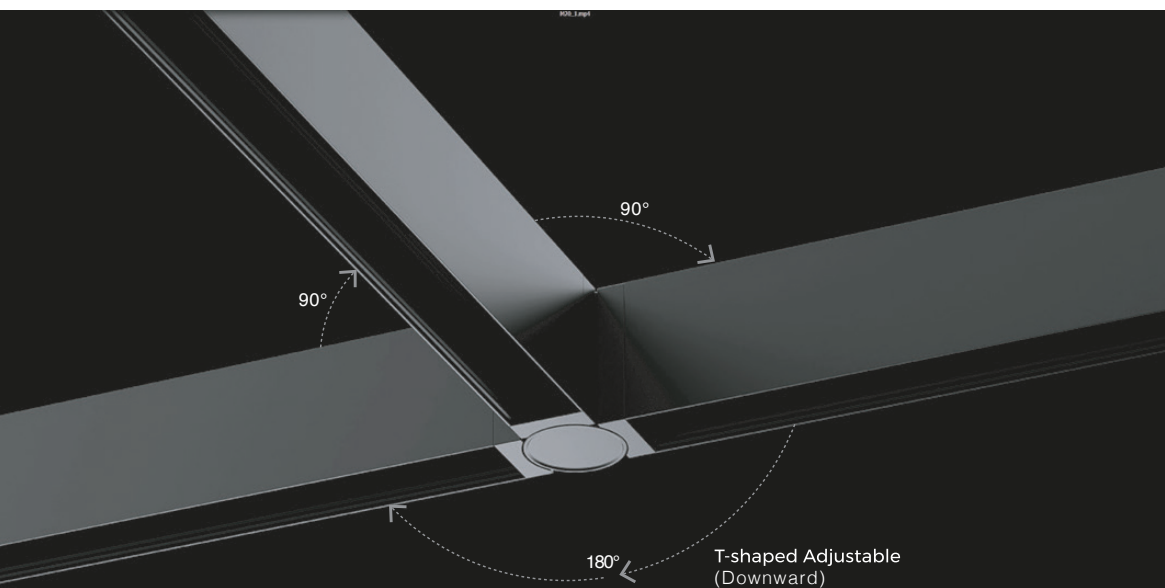
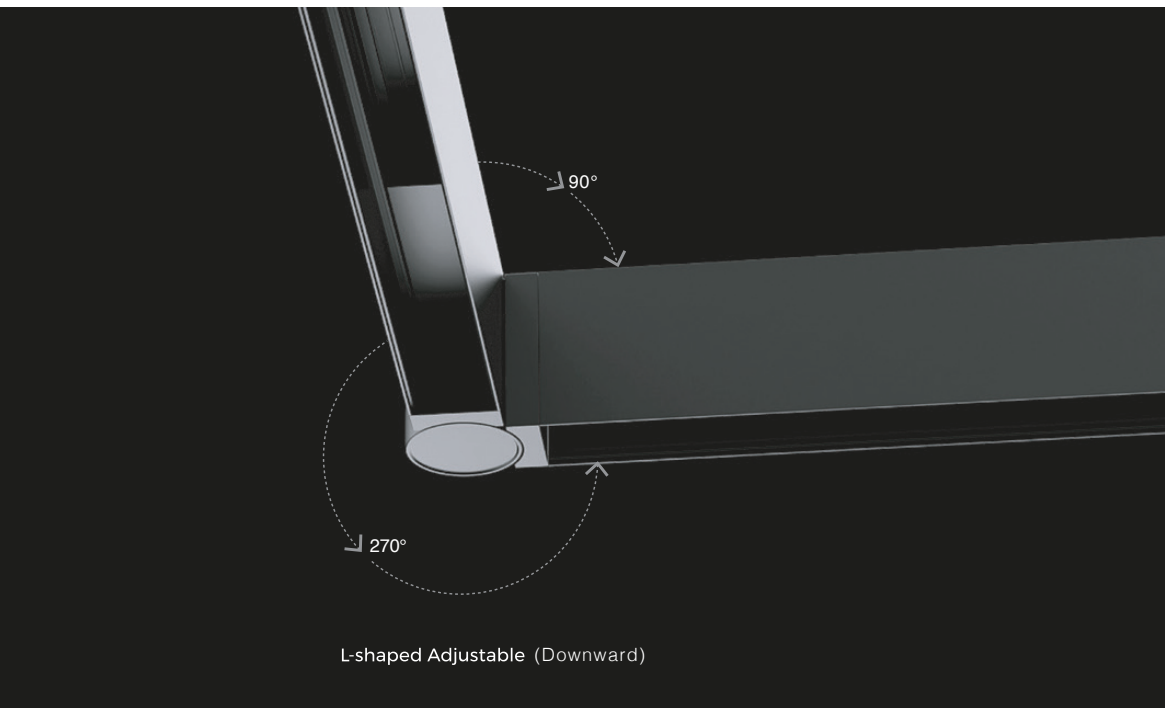



X-shaped Adjustable
(Downward)

*Only applicable to exposed loading and hoisting tracks

Corner accessory

Five finished accessories, no cutting required

Seamless splicing, excellent aesthetics

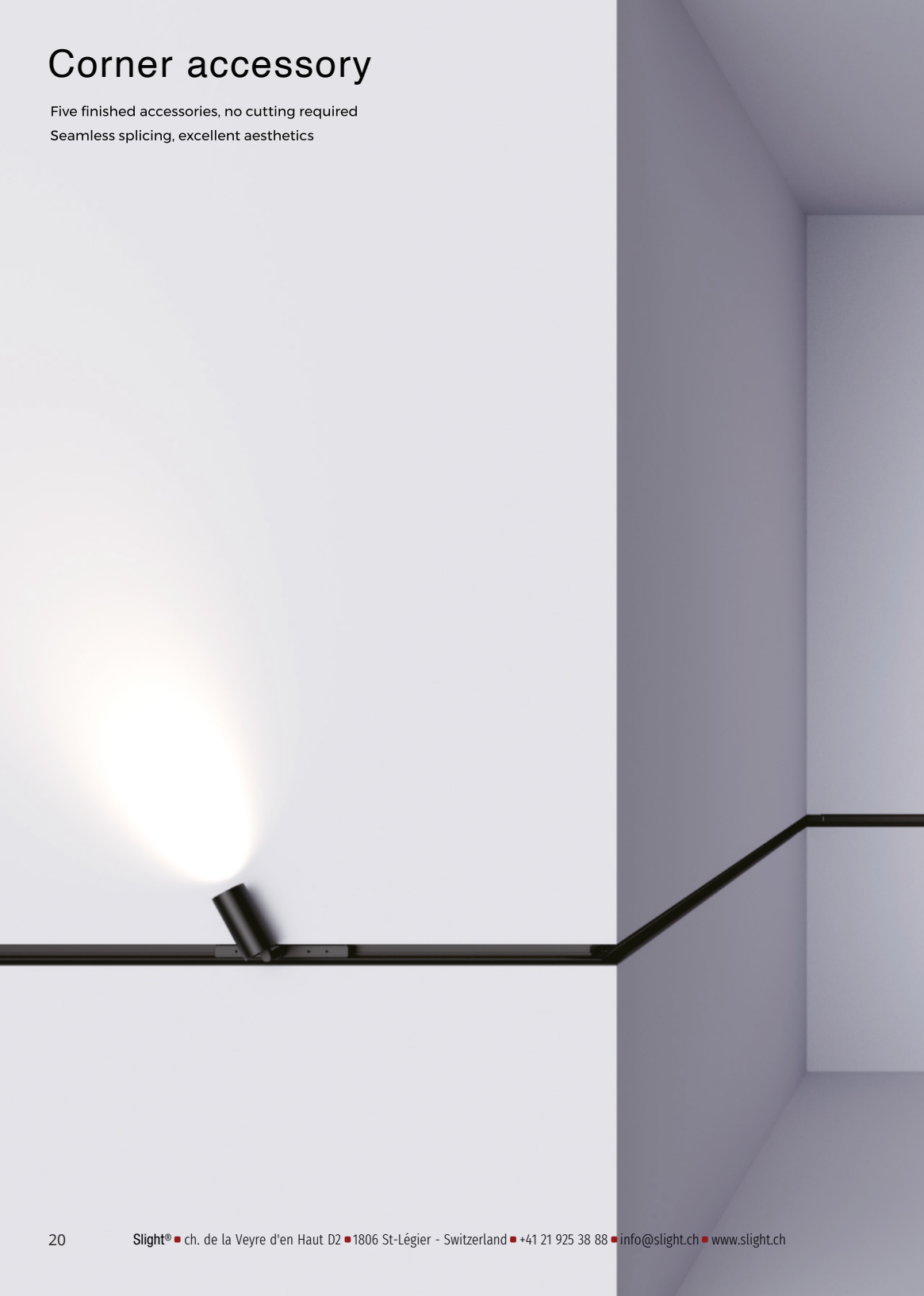

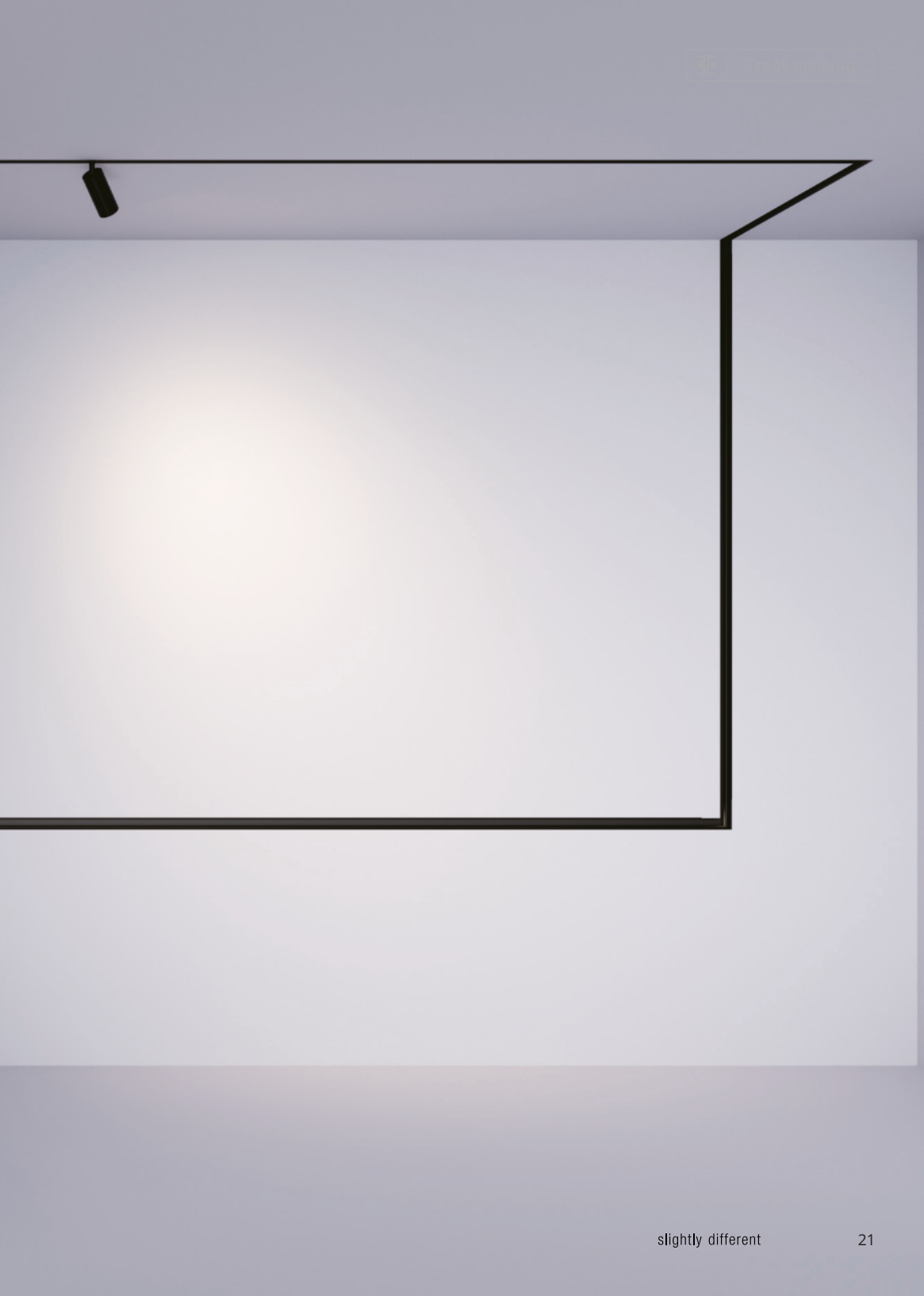

Easy installation

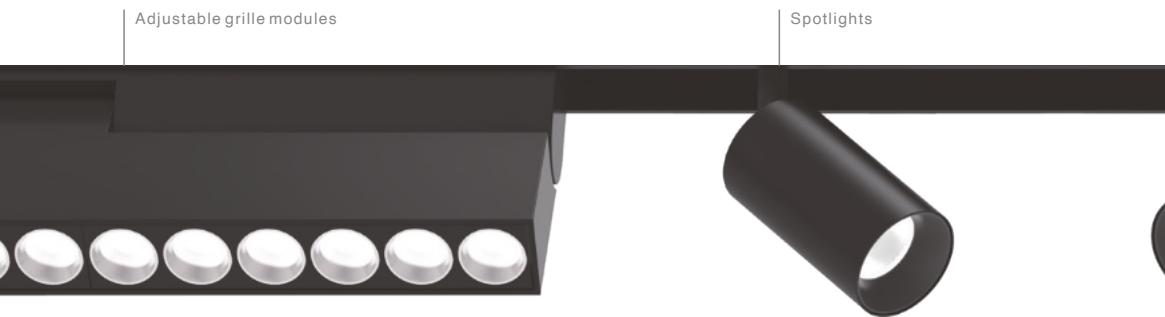

DIY combination of modules

Easy installation, pre-embed track and attach modules in seconds magnetically.

Modular system, satisfies various lighting demands.

Movable and angle adjustable, add flexibility to light designs.

Low-voltage, safe to touch and use.

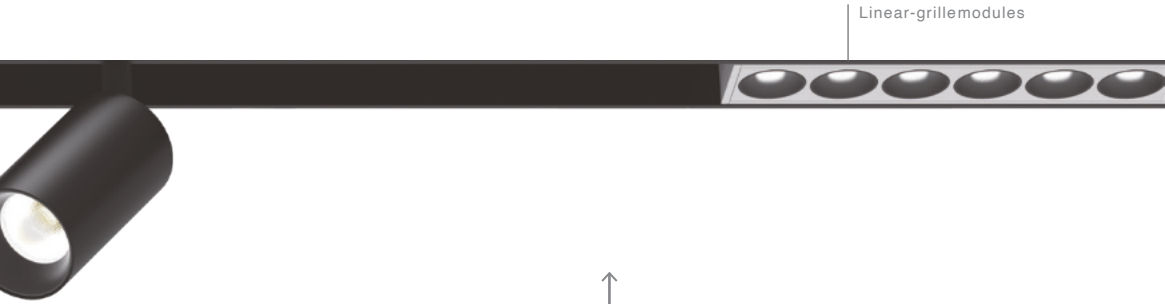

Linear-grillemodules

↑
Move close, get attracted instantly
↓



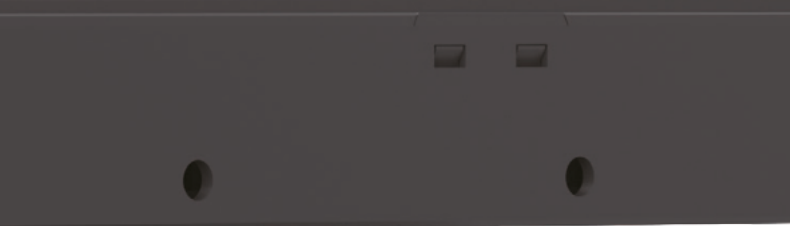

3CCT Dial-switch

3000 K 3800 K 5000 K



All-metal housing
Minimalist appearance



Adaptive Voltage24-48V

24V Magnetic Track



48V Magnetic Track

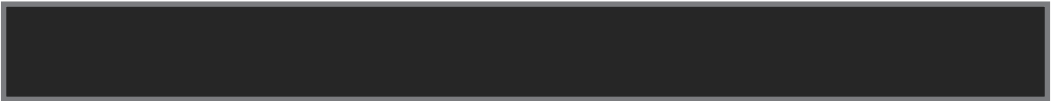

Systematic lighting, Effortless assembly

Straight Track

Ceiling / Pendant track

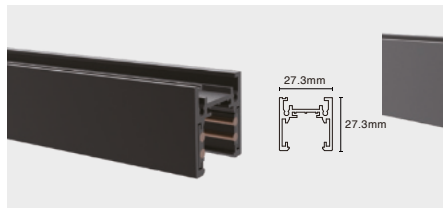

TLS-MS2X0 (X:1/ 2 / 3M)

Installation: Ceiling / Pendant

Material: AL6063-T5

Coating: Black

Size: 27.3x27.3x1000/2000/3000 m

Rated current: 12A

Operating Voltage	Maximum power
24V	300W
48V	580W

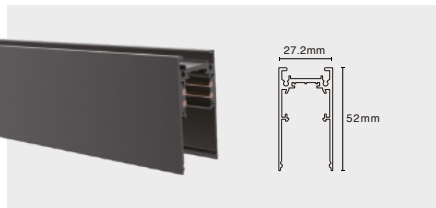

TLS-MH2X0 (X:1/ 2 / 3M)

Installation: Ceiling / Pendant

Material: AL6063-T5

Coating: Black

Size: 27.2x52x1000/2000/3000 m

Rated current: 12A

Operating Voltage	Maximum power
24V	300W
48V	580W

Trimless recessed track

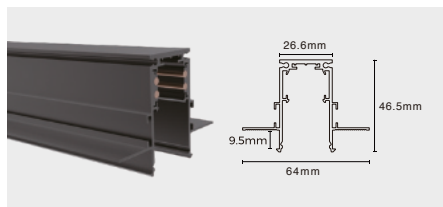

TLS-MR2X0(A) (X:1/ 2 / 3M)

9.5mm gypsum board

Installation: Trimless recessed

Material: AL6063-T5

Coating: Black

Size: 64x46.5x1000/2000/3000 m

Rated current: 12A

Operating Voltage	Maximum power
24V	300W
48V	580W

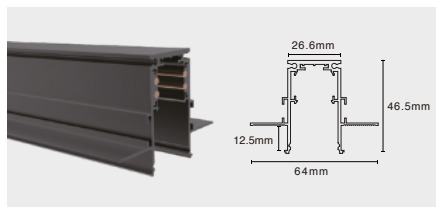

TLS-MR2X0(B) (X:1/ 2 / 3M)

12.5mm gypsum board

Installation: Trimless recessed

Material: AL6063-T5

Coating: Black

Size: 64x46.5x1000/2000/3000 m

Rated current: 12A

Operating Voltage	Maximum power
24V	300W
48V	580W

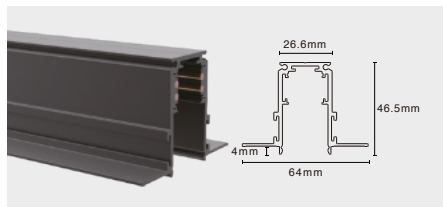

TLS-MR2X0(C) (X:1/ 2 / 3M)

plastered

Installation: Trimless recessed

Material: AL6063-T5

Coating: Black

Size: 64x46.5x1000/2000/3000 m

Rated current: 12A

Operating Voltage	Maximum power
24V	300W
48V	580W

Curve track



Ceiling / Pendant track

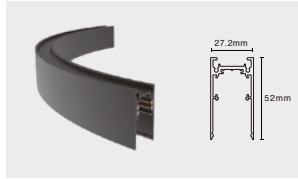

TLS-MH208A90

Installation: Ceiling / Pendant

Material: AL6063-T5

Coating: Black

Rated current: 7.5A

Operating Voltage	Maximum power
24V	180W
48V	360W

Size: 27.2x52xΦ800mm, 90°

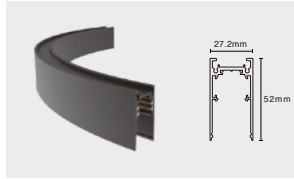

TLS-MH210A90

Installation: Ceiling / Pendant

Material: AL6063-T5

Coating: Black

Rated current: 7.5A

Operating Voltage	Maximum power
24V	180W
48V	360W

Size: 27.2x52xΦ1000mm, 90°

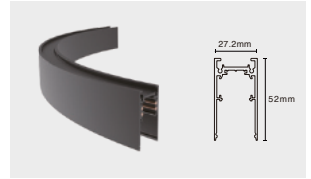

TLS-MH212A90

Installation: Ceiling / Pendant

Material: AL6063-T5

Coating: Black

Rated current: 7.5A

Operating Voltage	Maximum power
24V	180W
48V	360W

Size: 27.2x52xΦ1200mm, 90°

Trimless track (9.5mm gypsum board)

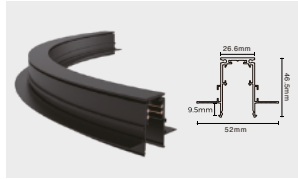

TLS-MR208A90(A)

Installation: Trimless recessed

Material: AL6063-T5

Coating: Black

Rated current: 7.5A

Operating Voltage	Maximum power
24V	180W
48V	360W

Size: 52x46.5xΦ800mm, 90°

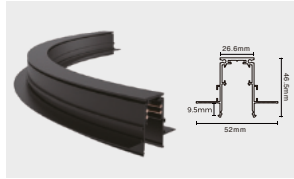

TLS-MR210A90(A)

Installation: Trimless recessed

Material: AL6063-T5

Coating: Black

Rated current: 7.5A

Operating Voltage	Maximum power
24V	180W
48V	360W

Size: 52x46.5xΦ1000mm, 90°

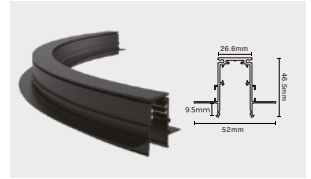

TLS-MR212A90(A)

Installation: Trimless recessed

Material: AL6063-T5

Coating: Black

Rated current: 7.5A

Operating Voltage	Maximum power
24V	180W
48V	360W

Size: 52x46.5xΦ1200mm, 90°

Trimless track (12.5mm gypsum board)

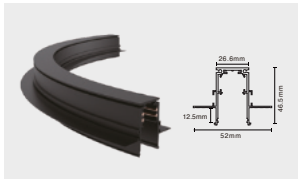

TLS-MR208A90(B)

Installation: Trimless recessed

Material: AL6063-T5

Coating: Black

Rated current: 7.5A

Operating Voltage	Maximum power
24V	180W
48V	360W

Size: 52x46.5xΦ800mm, 90°

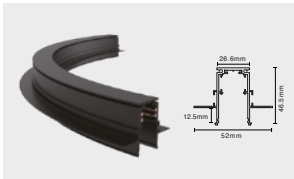

TLS-MR210A90(B)

Installation: Trimless recessed

Material: AL6063-T5

Coating: Black

Rated current: 7.5A

Operating Voltage	Maximum power
24V	180W
48V	360W

Size: 52x46.5xΦ1000mm, 90°

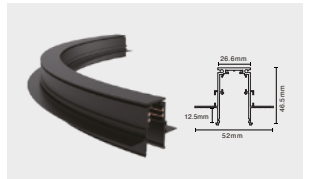

TLS-MR212A90(B)

Installation: Trimless recessed

Material: AL6063-T5

Coating: Black

Rated current: 7.5A

Operating Voltage	Maximum power
24V	180W
48V	360W

Size: 52x46.5xΦ1200mm, 90°

Track accessories

Electrical connection accessory



Power feeder of track
Model: TLS-M261
Size: L147×W19×H17.3mm
Applicable model: All staight track



I-shaped electrical connector
(recessed type)
Model: TLS-M265
Size: L70×W11.5×H2.1mm(Splicing bar)
L78×W19×H17mm(Power feeder)
Applicable model: TLS-MR2X0A
TLS-MR2X0B
TLS-MR2X0C



I-shaped electrical connector
(Surface)
Model: TLS-M266
Size: L55×W22×H4.3mm(Splicing bar)
L78×W19×H17mm(Power feeder)
Applicable model: TLS-MS2X0
TLS-MH2X0



Electrical connector
Model: TLS-M264
Size: L147×W19×H17.3mm
Applicable model:
All staight track corner

End cap



Model: EC-MH20
Material: Aluminum
Size: L52×W27.2×H5.5mm
Applicable model: TLS-MH2X0



Model: EC-MR20
Material: Aluminum
Size: L46.5×W27.5×H5.5mm
Applicable model: TLS-MR2X0(A)
TLS-MR2X0(B)
TLS-MR2X0(C)



Model: EC-MS20
Material: Aluminum
Size: L27.6×W27.5×H2.5mm
Applicable model: TLS-MS2X0

Intallation accessory

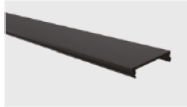

Track bind cover
Model: CV-M20FB
Material: PVC
Size: L1000×W25.7×H5.6mm
Applicable model: All staight track



Ceiling accessory
Model: TLS-M271
Material: SPCC
Size: L67.5×W31.5×H7.5mm
Applicable model: TLS-MS2X0
TLS-MH2X0



Pendant accessory
Model: TLS-M272
Material: AL6063-T5
Size: L30×W22×H4.3mm
Applicable model: TLS-MS2X0
TLS-MH2X0



Ceiling screw
Model: CL-01
Material: Fe
Size: M3.5×40mm
Applicable model: TLS-MR2X0(A)
TLS-MR2X0(B)
TLS-MR2X0(C)

Power supply



Magnetic power
 Model: MT20-HDRV100H48S-M
 Size: L248xW22.5xH46mm
 Input voltage: 220-240VAC
 Output: DC48V
 Power:100W
 Applicable model: All staight track



Magnetic power
 Model: MT20-HDRV200H48S-M
 Size: L305xW22.5xH46mm
 Input voltage: 220-240VAC
 Output: DC48V
 Power:200W
 Applicable model: All staight track



Power supply
 Model: BN-V48-100P
 Size: L350xW30xH18mm
 Input voltage: 220-240VAC
 Output: DC48V
 Power:100W
 Applicable model: All track



Power supply
 Model: BN-V48-250P
 Size: L400xW40xH22mm
 Input voltage: 220-240VAC
 Output: DC48V
 Power:250W
 Applicable model: All track

Corner accessory



L-shaped (Downward)
 Model: L90-MR20(A)
 Material: AL6063-T5
 Size: L95xW95xH46.5mm
 Applicable model: TLS-MR2X0(A)



L-shaped (Inward)
 Model: L90N-MR20(A)
 Material: AL6063-T5
 Size: L80xW80xH64mm
 Applicable model: TLS-MR2X0(A)



L-shaped (Downward)
 Model: L90-MR20(B)
 Material: AL6063-T5
 Size: L95xW95xH46.5mm
 Applicable model: TLS-MR2X0(B)



L-shaped (Inward)
 Model: L90N-MR20(B)
 Material: AL6063-T5
 Size: L80xW80xH64mm
 Applicable model: TLS-MR2X0(B)



L-shaped (Downward)
 Model: L90-MR20(C)
 Material: AL6063-T5
 Size: L95xW95xH46.5mm
 Applicable model: TLS-MR2X0(C)



L-shaped (Inward)
 Model: L90N-MR20(C)
 Material: AL6063-T5
 Size: L80xW80xH64mm
 Applicable model: TLS-MR2X0(C)



L-shaped (Downward)
 Model: L90-MS20
 Material: AL6063-T5
 Size: L50xW50xH27.3mm
 Applicable model: TLS-MS2X0



L-shaped (Inward)
 Model: L90N-MS20
 Material: AL6063-T5
 Size: L50xW50xH27.3mm
 Applicable model: TLS-MS2X0



L-shaped (Downward)
 Model: L90-MH20
 Material: AL6063-T5
 Size: L50xW50xH52mm
 Applicable model: TLS-MH2X0



L-shaped (Inward)
 Model: L90N-MH20
 Material: AL6063-T5
 Size: L80xW80xH27.2mm
 Applicable model: TLS-MH2X0



L-shaped Adjustable (Downward)
 Model: L90-MH20(A)
 Material: AL6063-T5
 Size: L120xW27.2xH52mm
 Applicable model: TLS-MH2X0



T-shaped Adjustable (Downward)
 Model: T90-MH20(A)
 Material: AL6063-T5
 Size: L120xW60xH52mm
 Applicable model: TLS-MH2X0



X-shaped Adjustable (Downward)
 Model: X90-MH20(A)
 Material: AL6063-T5
 Size: L120xW120xH52mm
 Applicable model: TLS-MH2X0



CASAMBI Control
 Model: 1200EN1812-CAS-W0-BLDAV48
 Size :142.6'18'58.1mm
 Input voltage :48VDC
 Output signal: DALI
 Output DALI Max.current:180mA
 Control devices:≤64

Control groups:≤8
 Certification:CE,UKCA
 Others:Controller should be used with
 DALI dimming modules.

Systematic lighting, Effortless assembly

ECO Straight Track

Ceiling / Pendant track

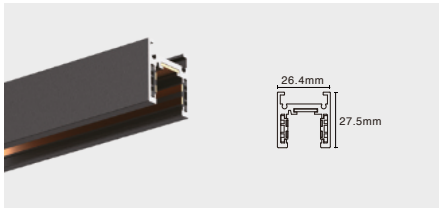

TLS-ECO-MS2X0 (X:1/ 2 / 3M)

Installation: Ceiling / Pendant

Material: AL6063-T5

Coating: Black

Size: 26.4x27.5x1000/2000/3000mm

Rated current: 7.5A

Operating Voltage	Maximum power
24V	180W
48V	360W

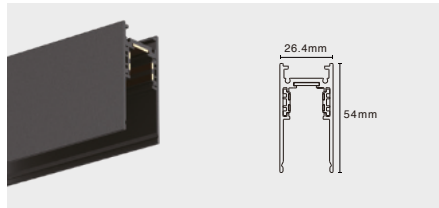

TLS-ECO-MH2X0 (X:1/ 2 / 3M)

Installation: Ceiling / Pendant

Material: AL6063-T5

Coating: Black

Size: 26.4x54x1000/2000/3000mm

Rated current: 7.5A

Operating Voltage	Maximum power
24V	180W
48V	360W

Trimless recessed track

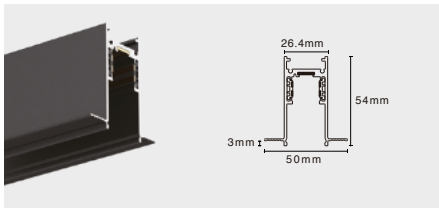

TLS-ECO-MR2X0 (X:1/ 2 / 3M)

3mm gypsum board

Installation: Trimless recessed

Material: AL6063-T5

Coating: Black

Size: 50x54x1000/2000/3000mm

Opening Size: 30x1000/2000/3000mm

Rated current: 7.5A

Operating Voltage	Maximum power
24V	180W
48V	360W

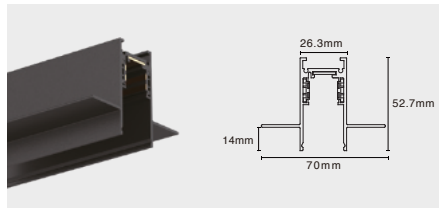

TLS-ECO-MR2X0(A) (X:1/ 2 / 3M)

12.5mm gypsum board

Installation: Trimless recessed

Material: AL6063-T5

Coating: Black

Size: 70x52.7x1000/2000/3000mm

Opening Size: 30x1000/2000/3000mm

Rated current: 7.5A

Operating Voltage	Maximum power
24V	180W
48V	360W

Track accessories

Electrical connection accessory



L-shaped (Downward)

Model: L90-ECO-MH20

Material: PC

Size: L99.5xW99.5xH46mm

Applicable model: TLS-ECO-MH2X0
TLS-ECO-MR2X0
TLS-ECO-MR2X0(A)



L-shaped (Downward)

Model: L90-ECO-MS20

Material: PC

Size: L99.5xW99.5xH21mm

Applicable model: TLS-ECO-MS2X0



L-shaped (Downward)

Model: L90-ECO-M281

Material: PC

Size: L143xW16.2xH17mm

Applicable model: TLS-ECO-MH2X0
TLS-ECO-MR2X0
TLS-ECO-MR2X0(A)
TLS-ECO-MS2X0

ECOEnd cap



Model: EC-ECO-MH20

Material: PC

Size: L52xW26xH6.3mm

Applicable model: TLS-ECO-MH2X0
TLS-ECO-MR2X0
TLS-ECO-MR2X0(A)



Model: EC-ECO-MS20

Material: PC

Size: L26.5xW21.2xH6.8mm

Applicable model: TLS-ECO-MS2X0

Intallation accessory



Pendant accessory

Model: TLS-ECO-M280

Material: AL6063-T5

Size: L33xW22.6xH2000mm

Applicable model: TLS-ECO-MS2X0
TLS-ECO-MH2X0

Spotlights module

MT20S-30
Φ30 mm spotlight



MT20S-42
Φ42mm spotlight



MT20S-52
Φ52mm spotlight



MT20S-62
Φ62mm spotlight



MT20SZ-45
Φ45mm zoom spotlight



MT20SZ-55
Φ55mm zoom spotlight



MT20SZ-65
Φ65mm zoom spotlight



Optics



Zoom Spotlight



Linearmodule

MT20GW

Wall washer



MT20FD

Diffuser

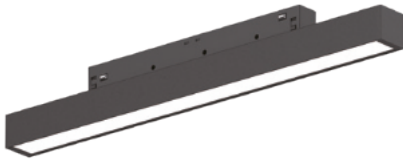

MT20FP

Prismatic

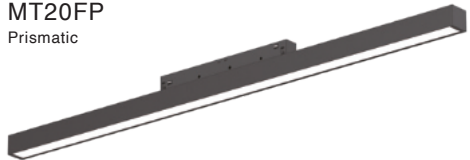

MT20LA

Asymmetric



MT20LS

Double Asymmetric

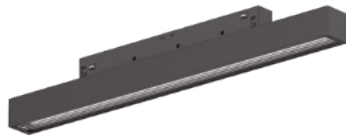

MT20G

Grating

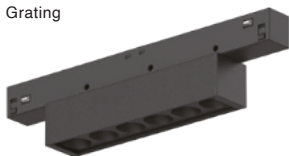

MT20G(A)

Grating

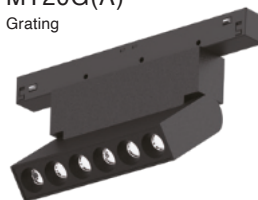

*The Angle is adjustable



Wall washer

Grating

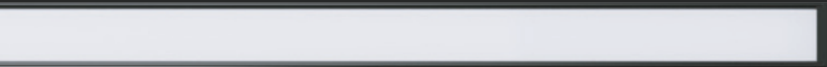

Diffuser

Prismatic

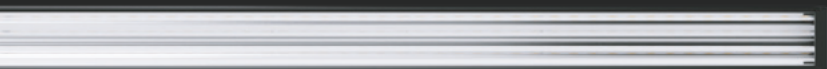

Asymmetric

Double Asymmetric



Block Frosted

Wall washer

The distance from the wall is 0.5m (real shot)



The distance from the wall is 0.8m real shot



The distance from the wall is 1m real shot



Grating



Diffuser



Prismatic

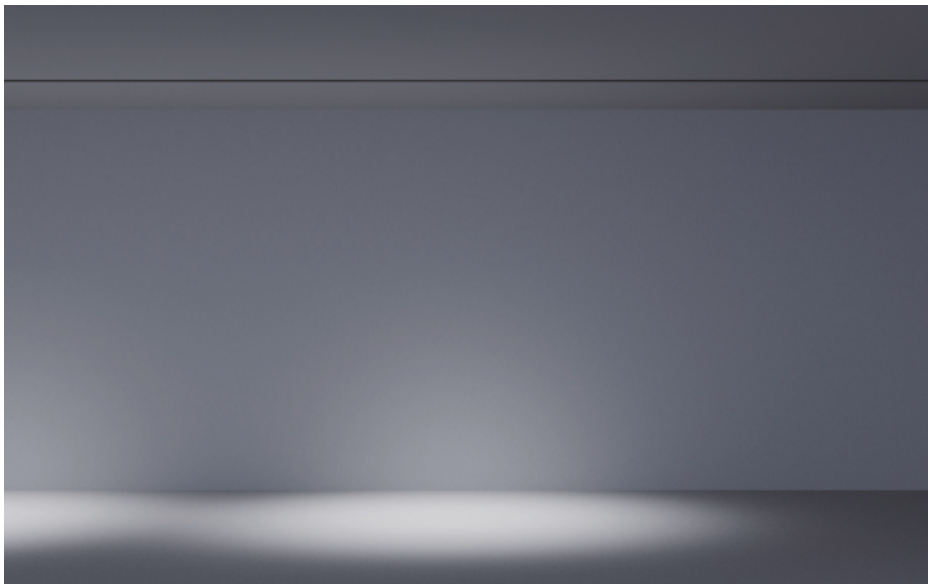

Asymmetric

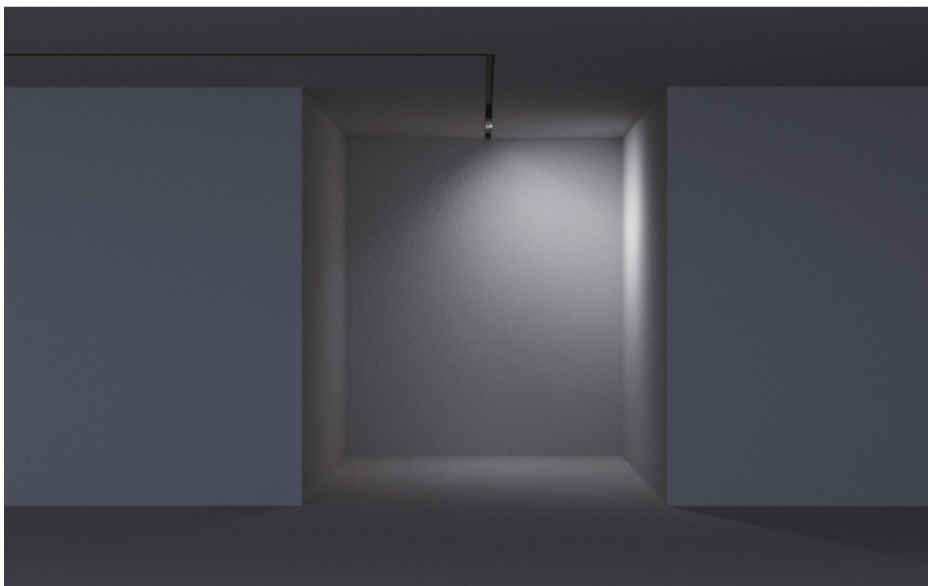

Double Asymmetric

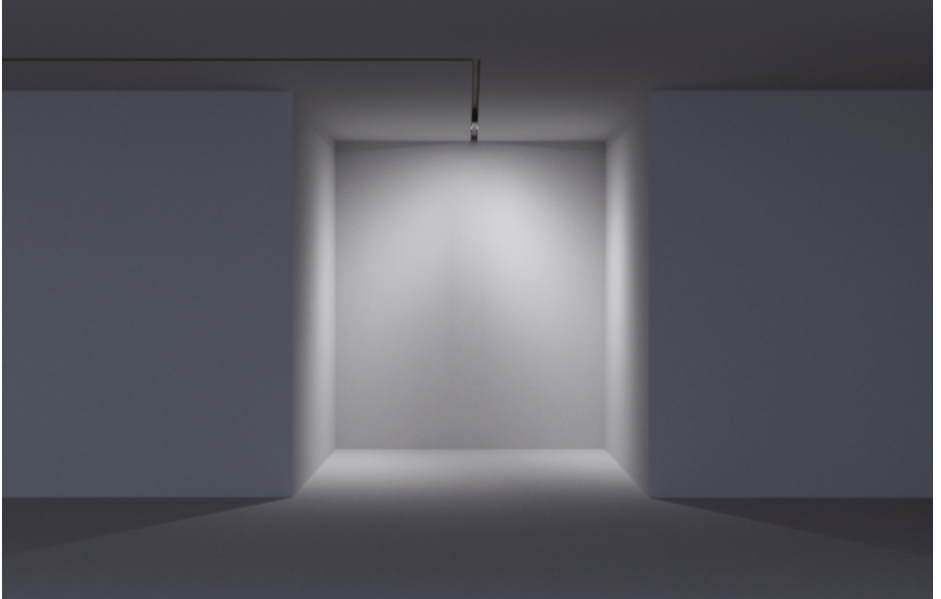

Block Frosted



MT20NK-25
Round neon



MT20NK-27
Square recessed neon

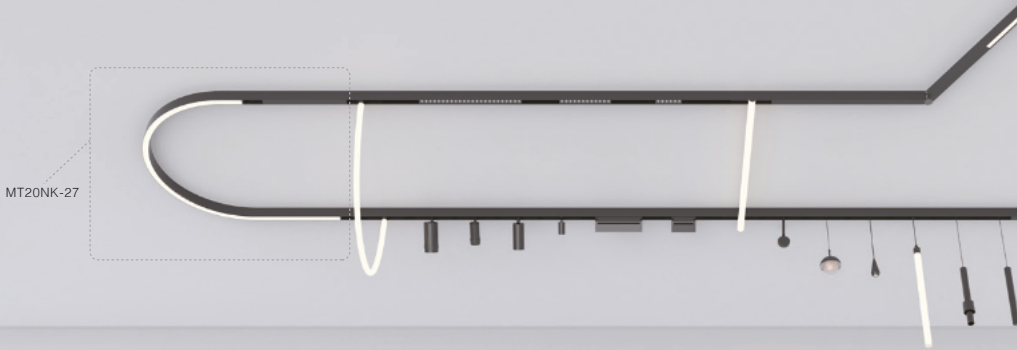

MT20CD
Round tube



MT20CD(A)
Cross-track round tube

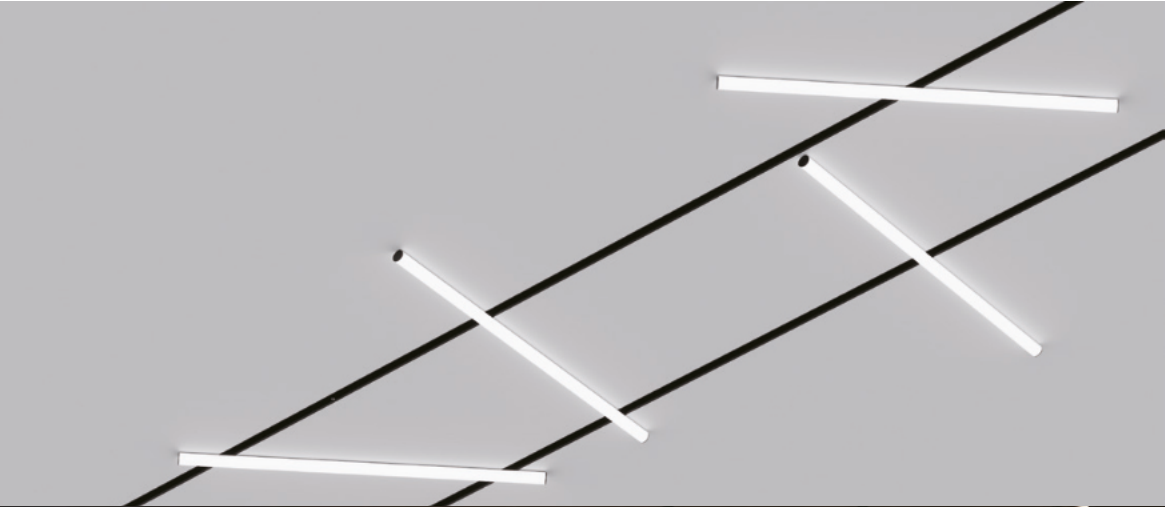

Decorativelight module

MT20SS

Sunset light



MT20IW

Waterdrop light



MT20I-30

Φ30mm spotlight



MT20I-50

Φ50mm spotlight





MT20IW
Waterdrop light



slightly different

MT201-30
Φ30mm spotlight



MT201J
Φ30mm Round tube light



MT201-50
Φ50mm spotlight

Easyinstallation



Intelligent control

CASAMBIDimming



Brightness Adjustment



Group & Scene Control



Brightness Gradient



Power-Off Memory



Remote Control



Bluetooth Dimming



Brightness Adjustment



Remote Control



Group & Scene Control



Timing & Delay Time



Brightness Gradient



Power-Off Memory



Do-Not-Disturb

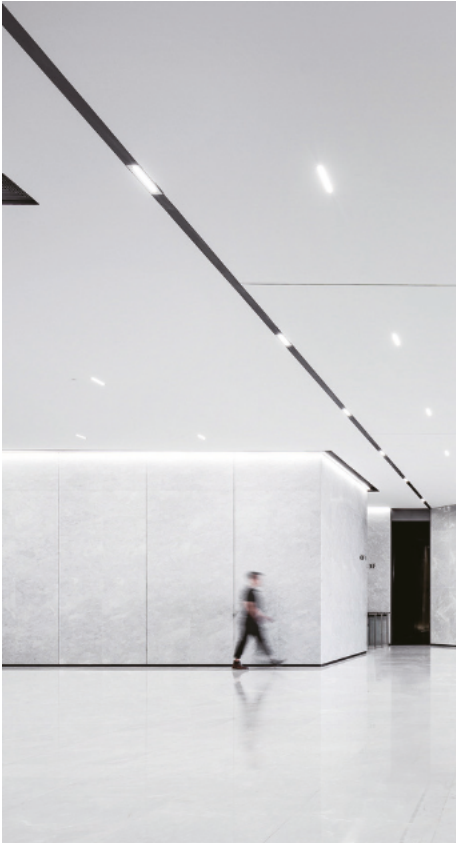

LIGHT UP MOBILE SMART LIFE

REMOTE DIMMING

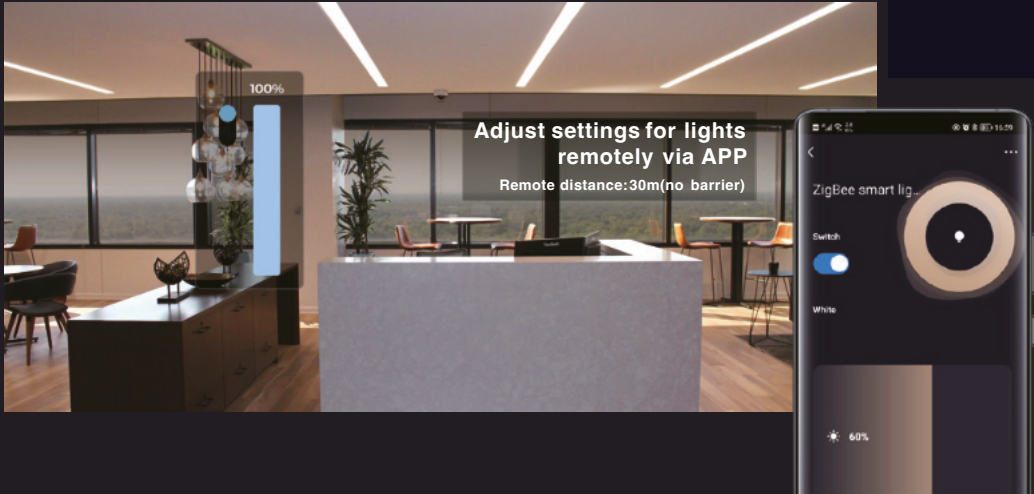

LIGHT SCENE

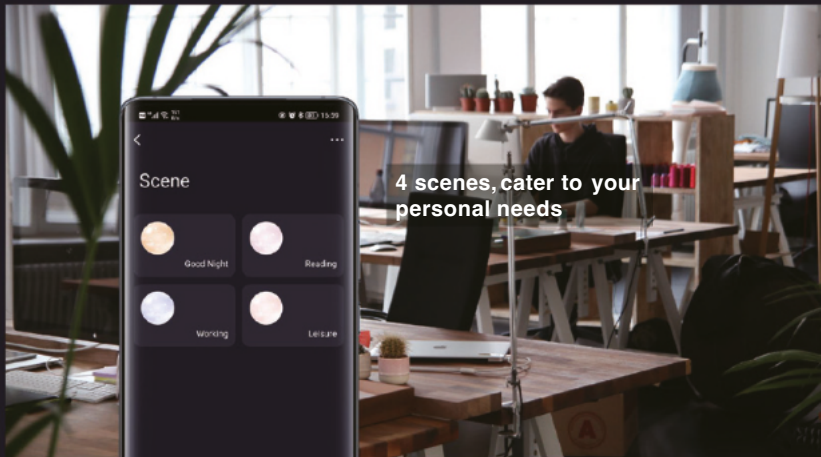

LIGHT UP MOBILE SMART LIFE

TIMING&DELAY TIME

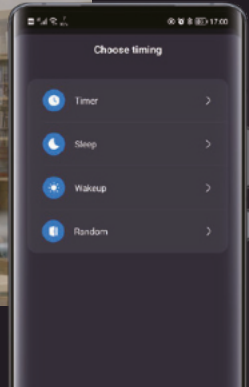
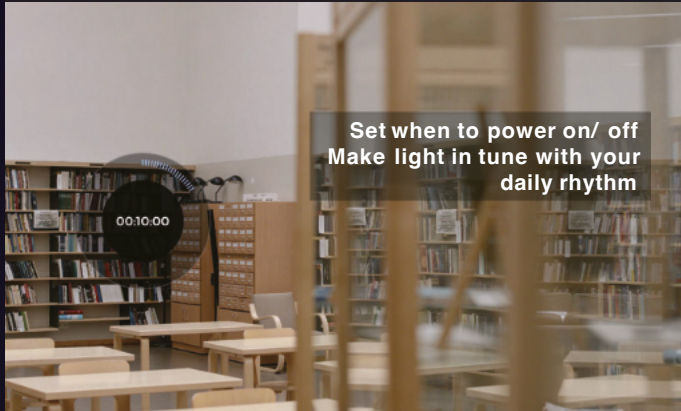

DEFAULT LIGHT

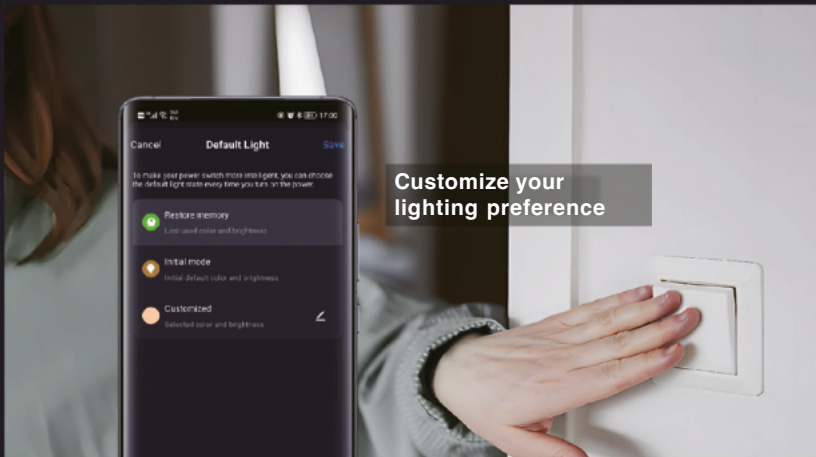

LIGHT UP MOBILE SMART LIFE

BRIGHTNESS GRADIENT



DO NOT DISTURB



REMOTE CONTROL

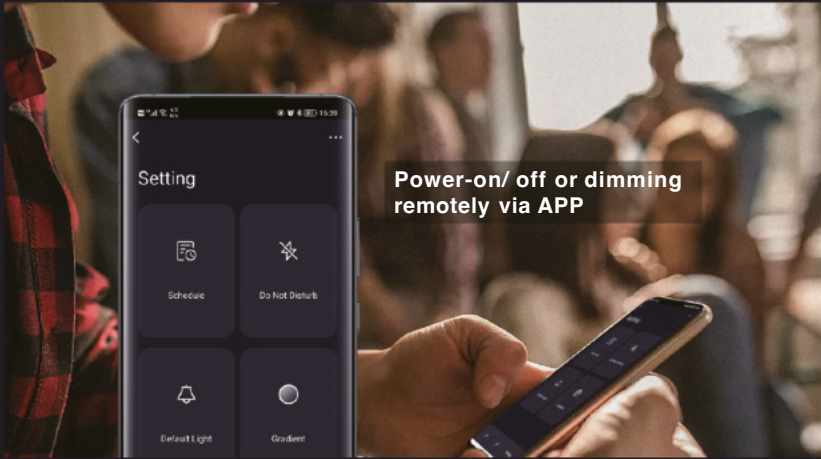

Case



Slight®
slightly different





Slight®
slightly different



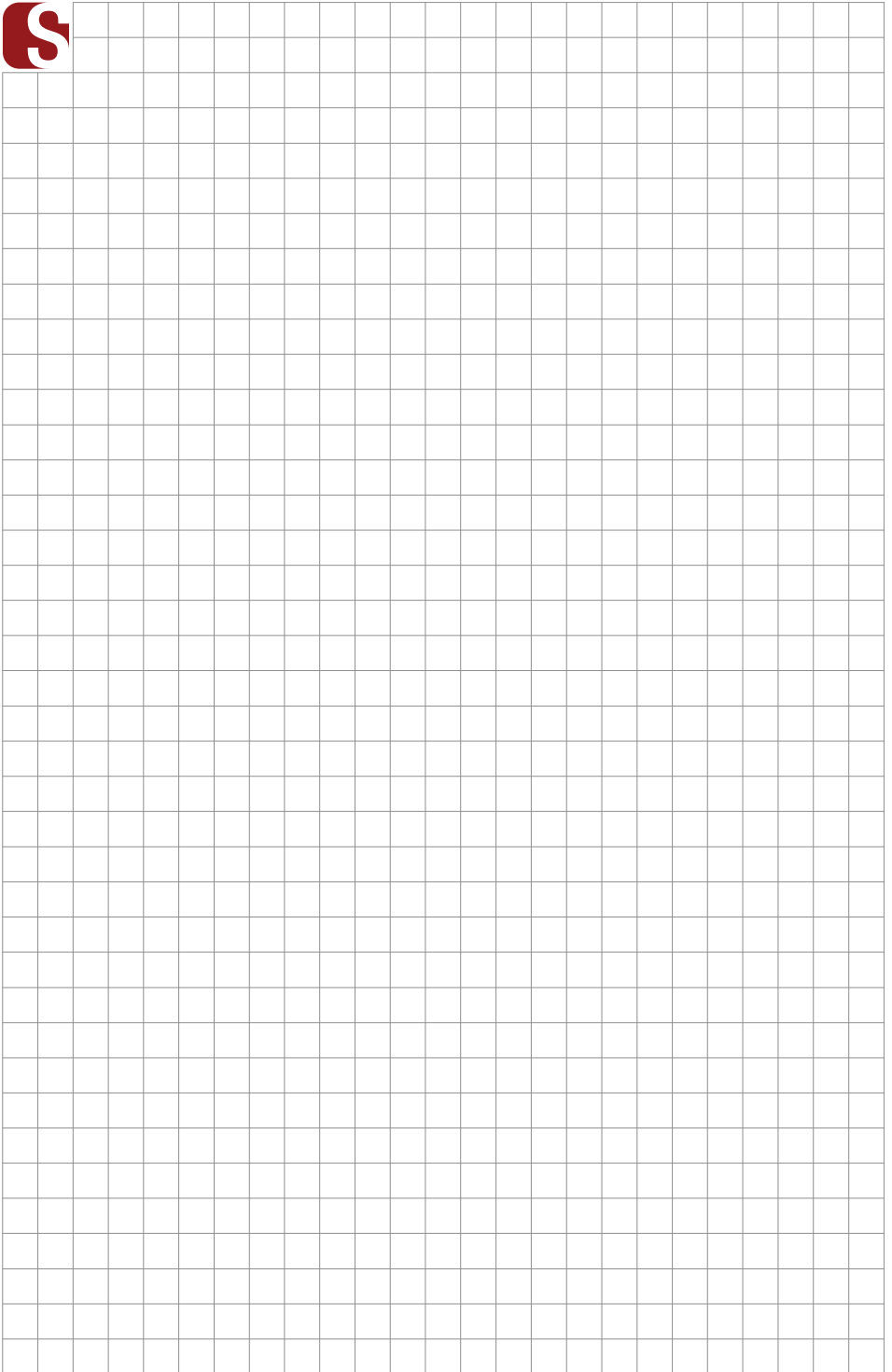

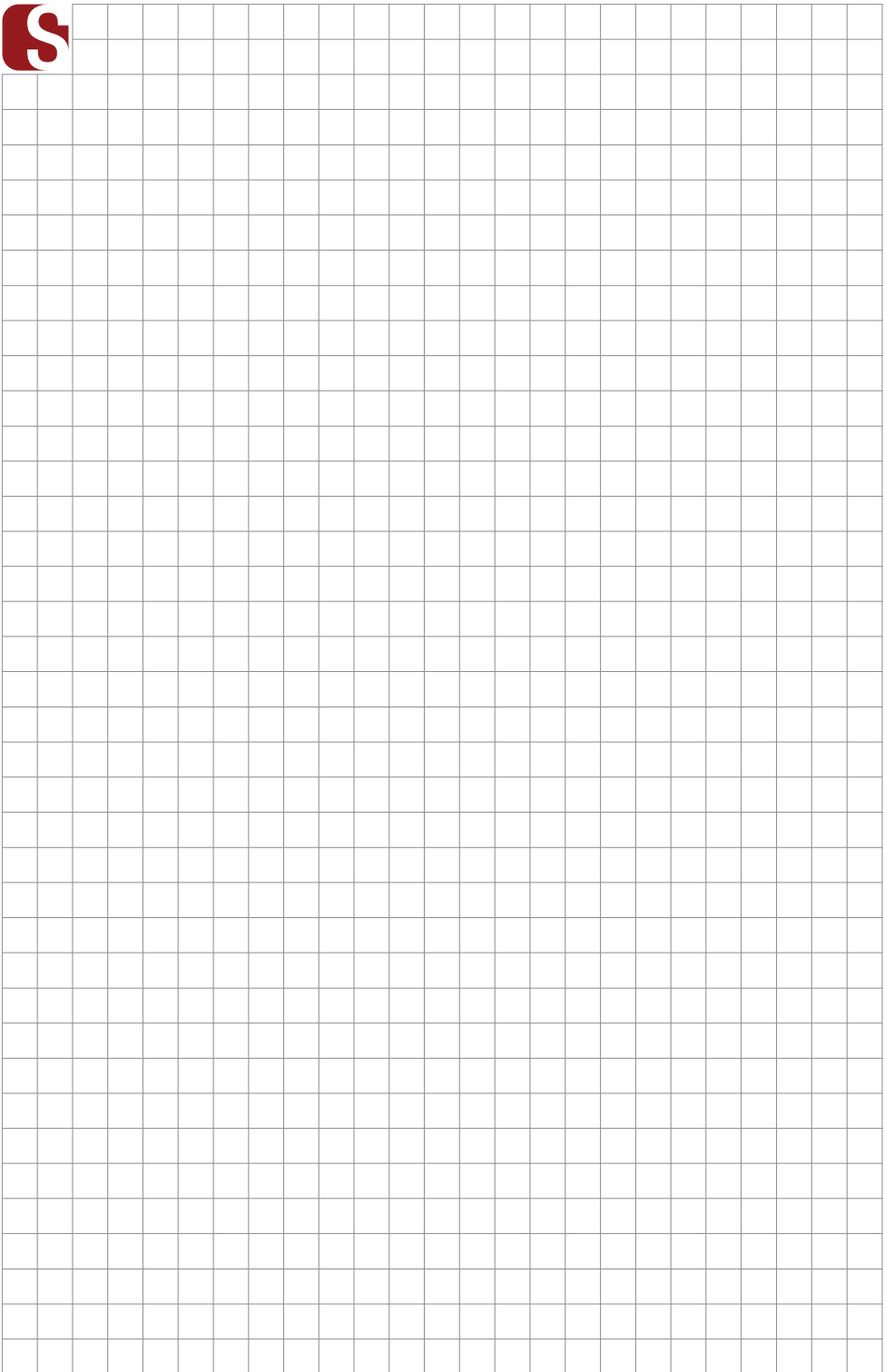

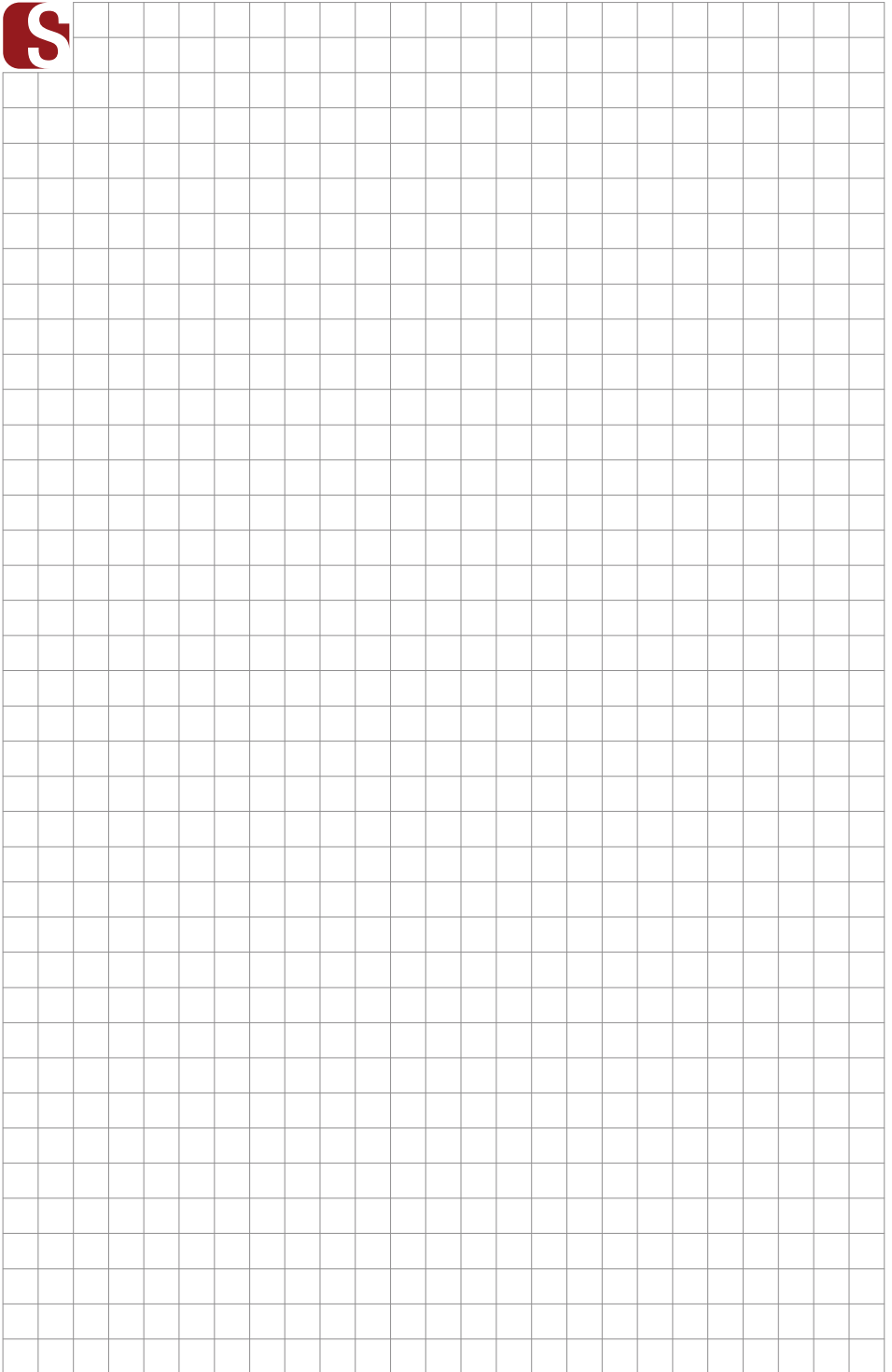

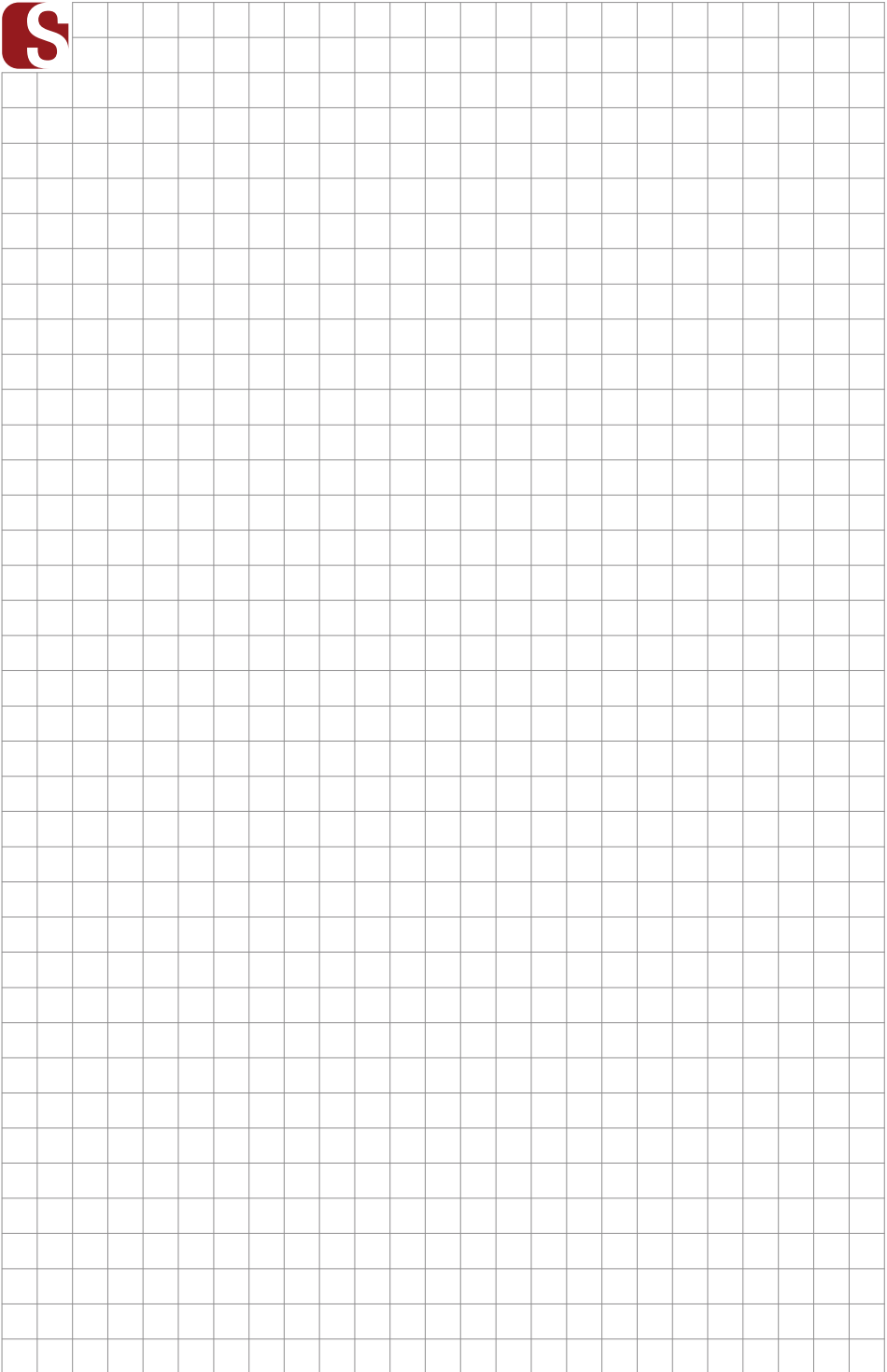

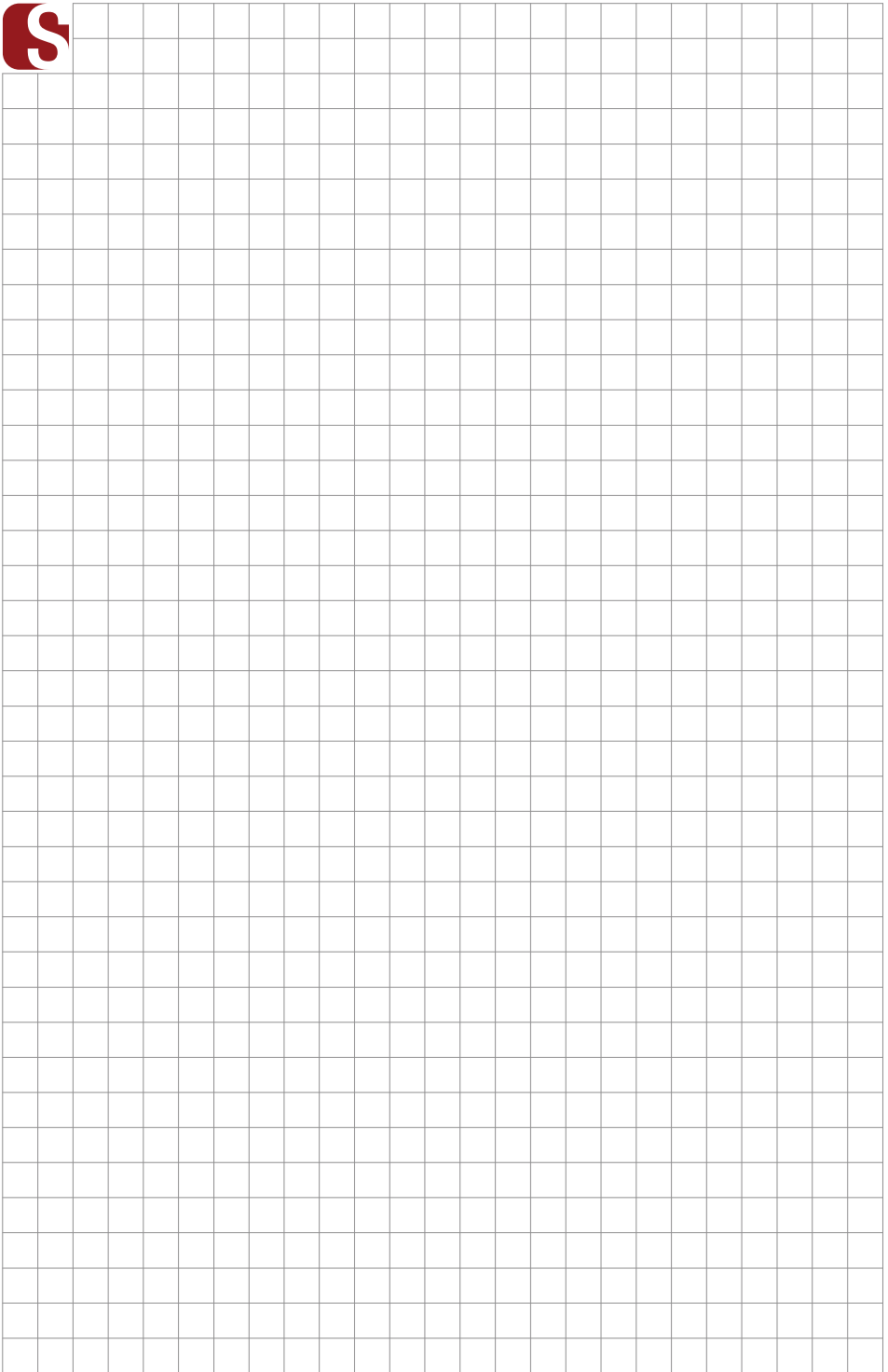

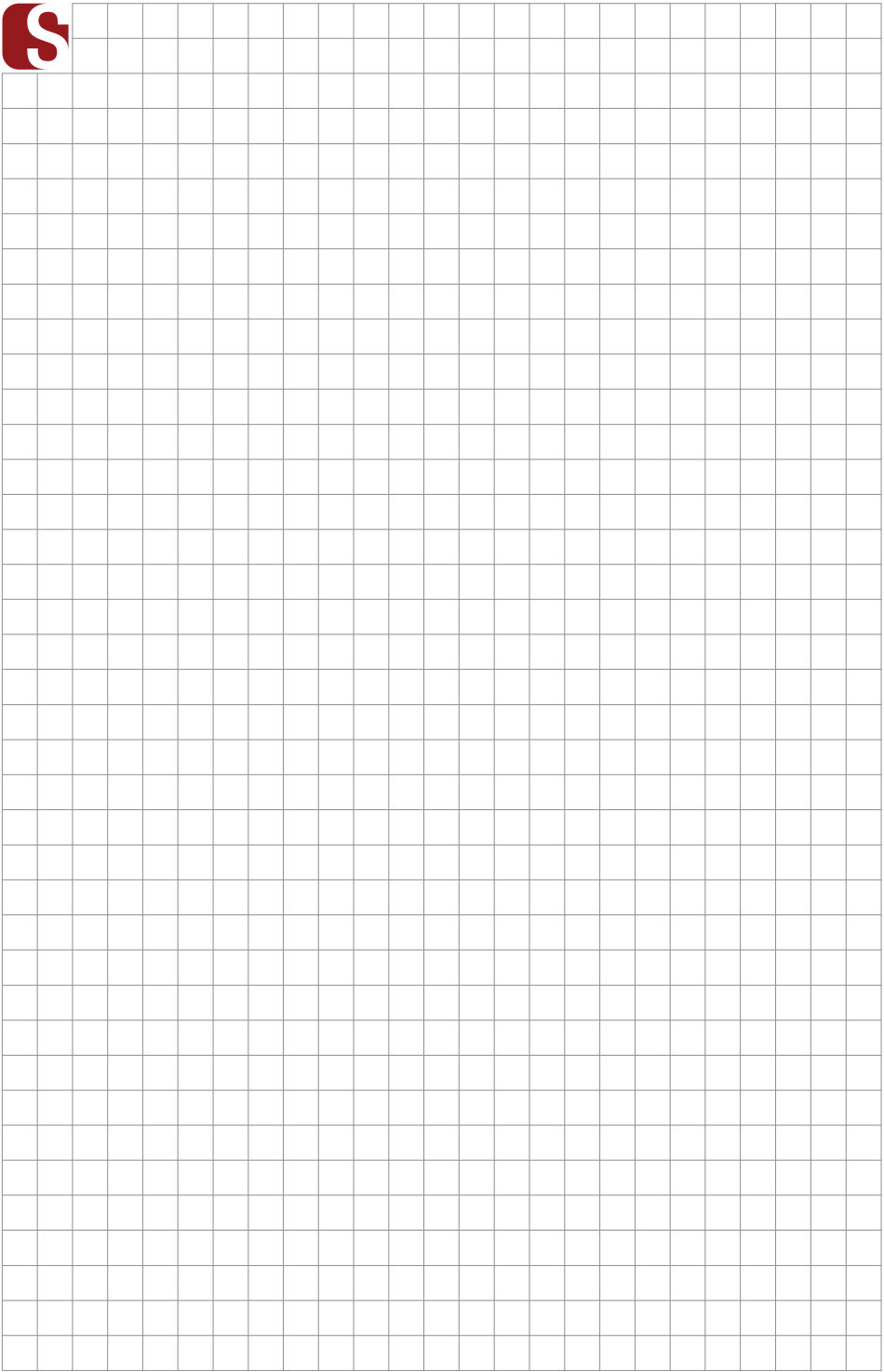

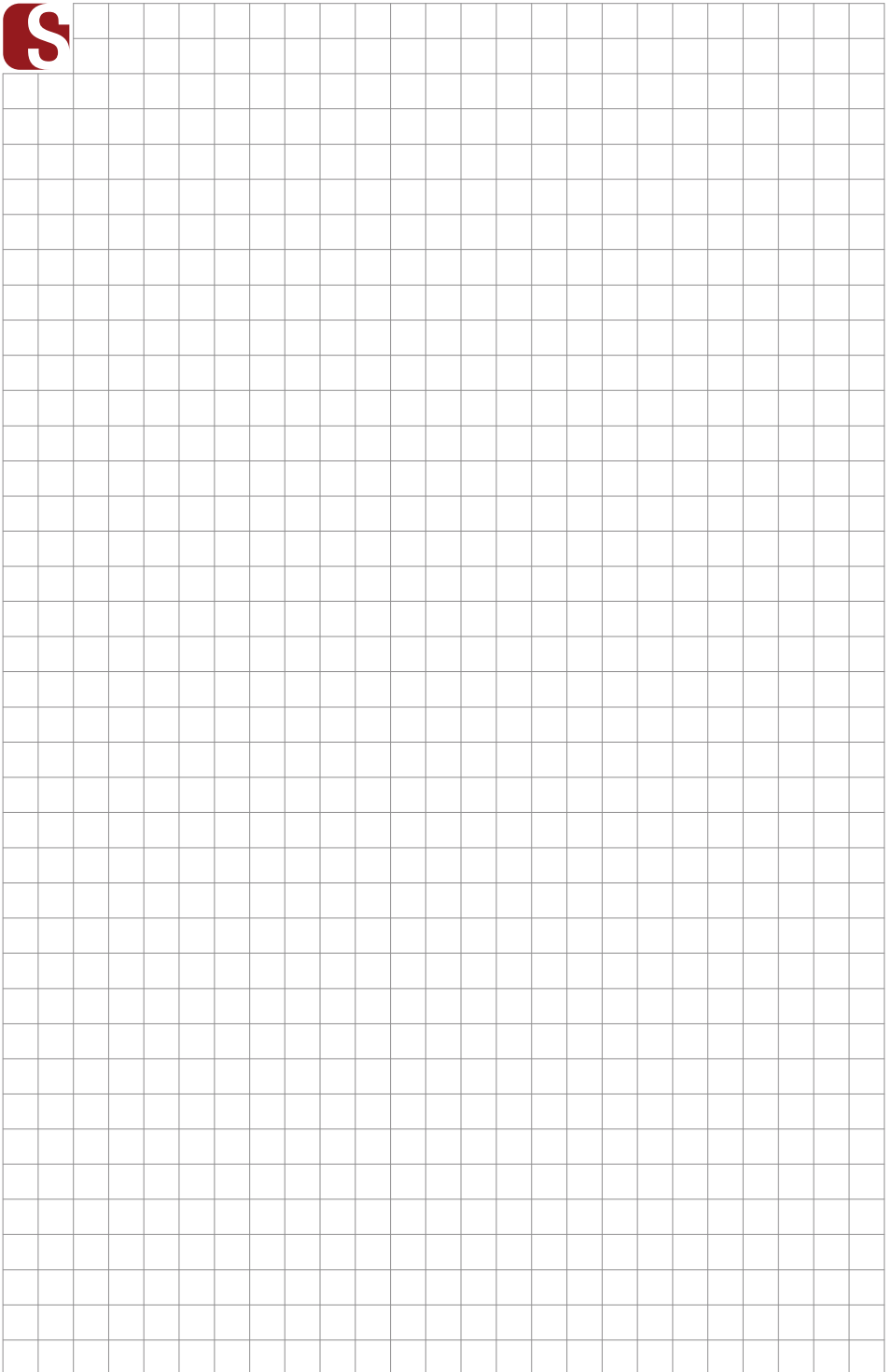

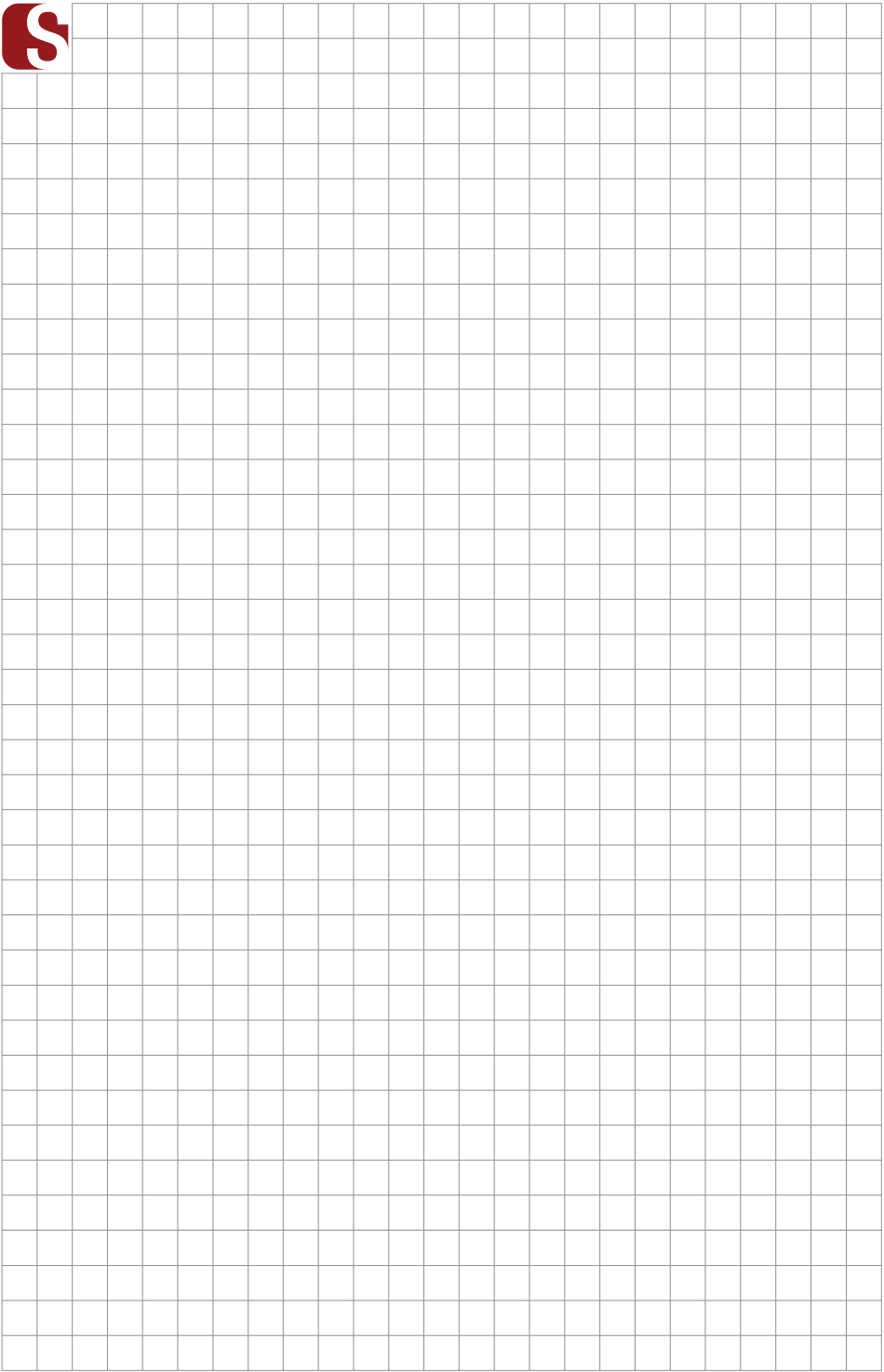

SLIGHT®

Chemin de la Veyre d'en haut D2

1806 St-Légier — Switzerland

+41 21 925 38 88

www.slight.ch

info@slight.ch